

# ATTACHMENTS COLLECTION

---

 **COMPTOIR DU LEVAGE**

Vente, location de matériel avec ou sans opérateur et gestion de projet

[comptoirdulevage.fr](http://comptoirdulevage.fr)

07 68 55 39 82 [contact@comptoirdulevage.fr](mailto:contact@comptoirdulevage.fr)

SIRET : 850 301 227 00011





**Quality, craftsmanship and innovation.  
The secret lies in precision. Having clear ideas is vital:  
we need to know where we want to go and what we want to create.  
And at Magni, we throw our all into accomplishing it.**

**Riccardo Magni – President**

---

Magni Telescopic Handlers was founded in 2013. Thus began the development of the widest range of telescopic handlers on the market; from rotating telescopic handlers to fixed, heavy-duty models and fixed-boom construction telescopic handlers. Italy was no longer enough and so six further branches have been set up: Magni TH France, Magni UK, Magni America, Magni Deutschland, Magni SA and Magni Asia Pacific. To offer our clients the best technical and commercial service around, we have created a network of over 300 dealers, a number that is constantly increasing. And that is just the beginning of our story.

# ATTACH MENTS COLLEC TION



## PLATFORMS

---

Magni offers a wide range of platforms, from the simplest, in order to be able to reach the desired heights in total safety, up to the most special models such as the one dedicated to working in the tunnel or the one for removing asbestos at high altitude. They are the perfect solution for the construction sector and for major maintenance works.

PAG. 07

## WINCHES

---

To effortlessly lift and move objects, more or less bulky, making the most of your Magni's performance, our range of winches is the ideal solution. Compact, sturdy, they are top quality accessories, which bear Magni's constructive signature in every design detail.

PAG. 19

## FORK CARRIAGES

---

Wide range to meet market needs and to assist our operators directly in the workplace. From the simplest fork carriers to those with heavy-duty capacities and larger fork sizes to be able to perform aggravating work in the most extreme conditions.

PAG. 29

## JIBS WITH/WITHOUT WINCH

---

Accessories that are widely used because they are highly versatile and performing, both from a lifting capacity point of view and for the wide choice of capacities offered. As always, Magni has designed a range of accessories specific to market demands, which can be used with every Magni in the catalog.

PAG. 49

## BUCKETS

---

The buckets complete the range of accessories in the Magni world, simplifying the processes in the construction and maintenance sector. They are also excellent allies for the recycling, agriculture and paper supply chain thanks to the various capacities and undisputed performances that they can offer to the professional users.

PAG. 79

## HOOKS

---

Simple but extremely versatile and resistant, Magni approved hooks offer a wide solution for use in the construction world. The range consists of hooks of different capacities to meet the specific needs of the market and to be able to work with all the machine models offered.

PAG. 61

## SPECIALS

---

Category entirely dedicated to accessories with very specific uses. These are codes used to carry out special works, such as removing large trees, cleaning the road with snow shovels, installing glass at high altitude and servicing aircraft. In Magni we are known for the tailoring skills to sew ad hoc solutions to each specific market request, even for the most demanding customers.

PAG. 85

## CLAMPS

---

Very specific accessories designed on stringent needs felt above all in the mining and extractive sector, and lately also of recycling. This is a range of accessories designed for changing tires of large truck dumpers used in the mine, capable of adapting to the performance of each Magni sold in the market.

PAG. 69

# VERSATILITY GUARANTEED WITH THE MAGNI RANGE OF ATTACHMENTS



The great potential of Magni machines is fully realized by choosing the right accessory among all possible options in the range. All accessories are interchangeable giving the possibility to have a machine capable of performing more than one task simply by changing accessories. If your Magni model is dated, we ask you to contact the sales force closest to you, to check its compatibility. All our attachments are available for almost all the markets and countries, please get in contact with your nearest dealers or Magni branch to have the best solution tailored for your needs.



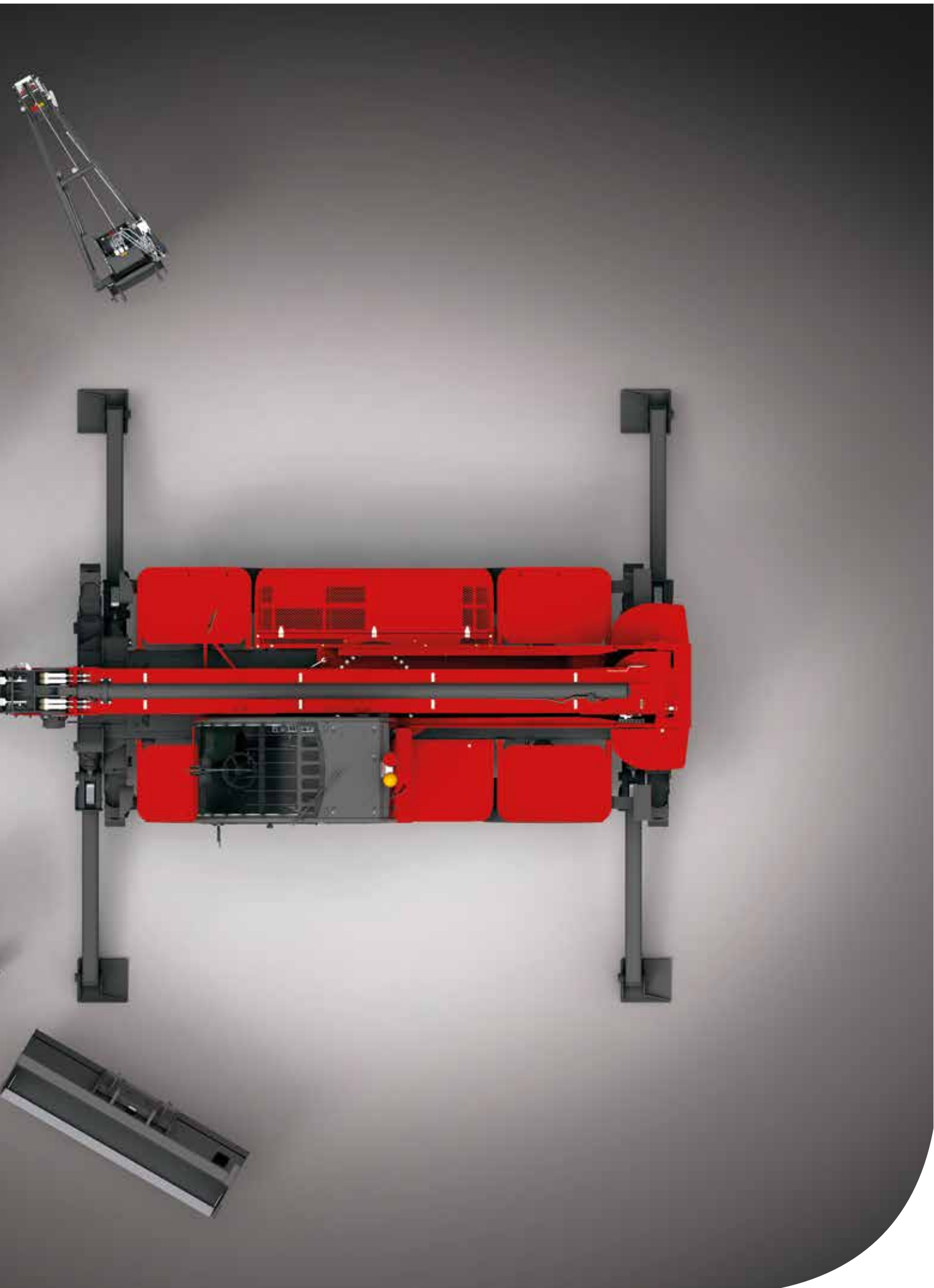

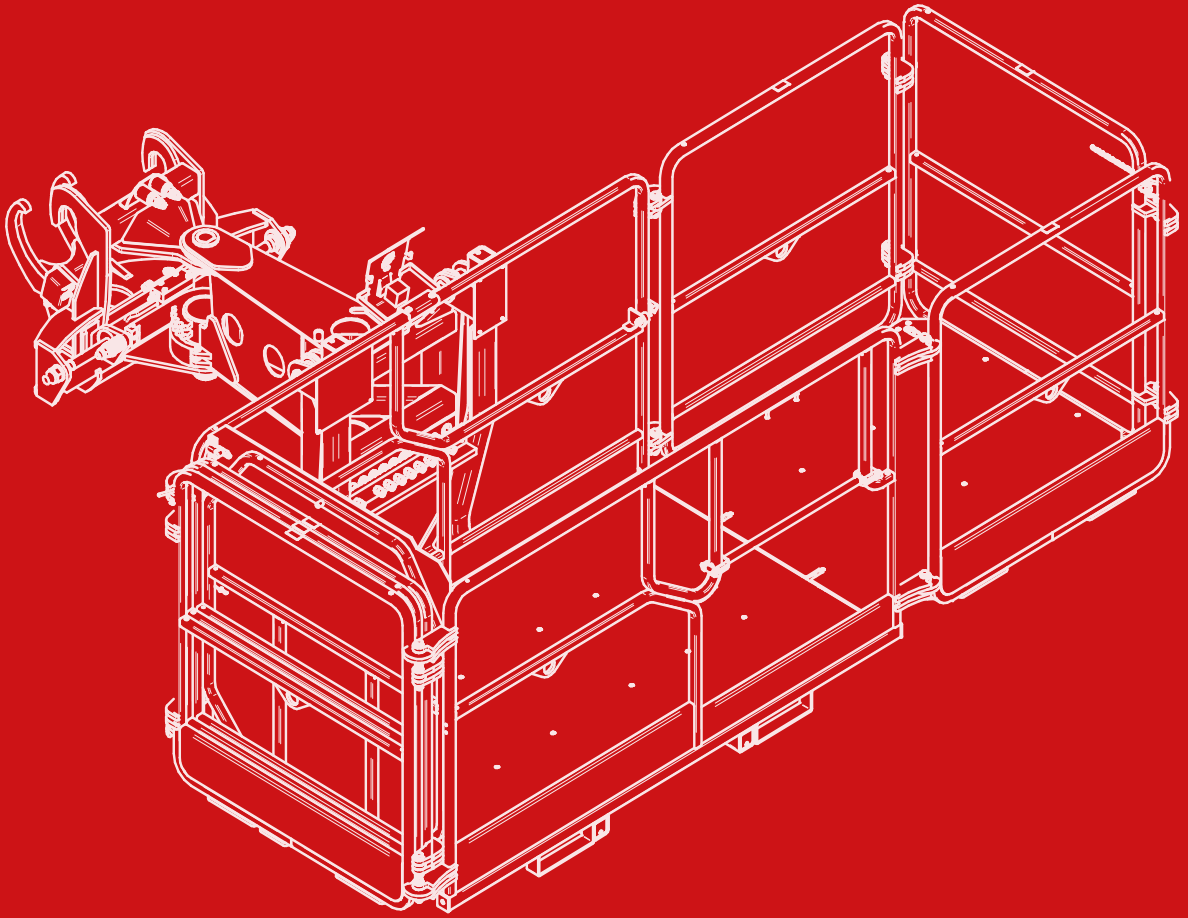



---

# PLATFORMS

Magni offers a wide range of platforms, from the simplest, in order to be able to reach the desired heights in total safety, up to the most special models such as the one dedicated to working in the tunnel or the one for removing asbestos at high altitude. They are the perfect solution for the construction sector and for major maintenance works.

**Warning:**

Compatibility depends also on the max capacity of the unit. please check max allowed weight. if in doubt, ask.



## PLATFORM

ATT - 01 - 001 Q-FIT I

Non-extendable platform with 250 kg maximum capacity, type approved to carry two persons. Galvanised, reinforced steel structure. Non-slip floor covering to ensure the utmost safety when working at height.

REMOTE CONTROL REQUIRED

**Suitable for**  
**RTH - TH**

P1,4

250 kg	1,400 x 700 mm	X	2	✓



## ROTATING PLATFORM

ATT - 01 - 003 Q-FIT I

Rotating platform (+/- 90°) with 250 kg maximum capacity, type approved to carry two persons. Galvanised, reinforced steel structure. Non-slip floor covering to ensure the utmost safety when working at height.

REMOTE CONTROL REQUIRED

**Suitable for**  
**RTH - TH**

RP1,4

250 kg	1,400 x 700 mm	+ / - 90°	2	✓



## ROTATING PLATFORM

ATT - 01 - 005 Q-FIT I

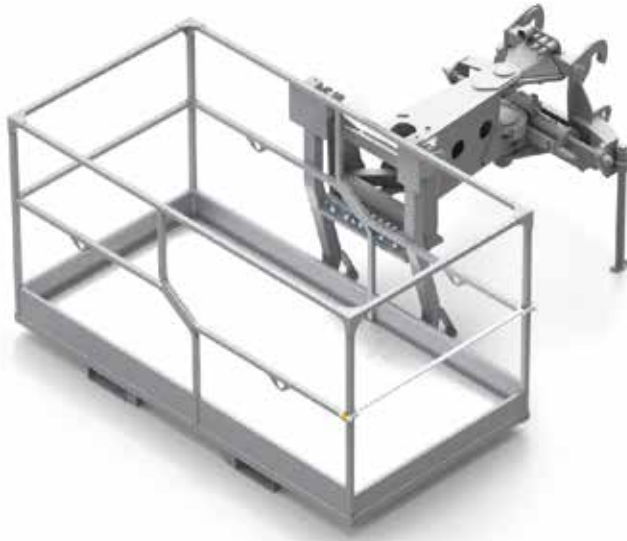

Non-extendable rotating platform with 500 kg maximum capacity, type approved to carry three persons. Galvanised, reinforced steel structure. Non-slip floor covering to ensure the utmost safety when working at height. Platform equipped with overload sensor and rack with a practical anti-shock system which ensures smooth, even rotational movements when stopping and starting movement. Equipped with practical fork slots for movement during storage.

REMOTE CONTROL REQUIRED

**Suitable for  
RTH**

### RP2,2

500 kg	2,200 x 1,100 mm	+ / - 90°	3	✓



## EXTENDABLE ROTATING PLATFORM 4.5

ATT - 01 - 007 Q-FIT I



Extendable rotating platform with 500 kg maximum capacity, type approved to carry three persons. Galvanised, reinforced steel structure. Non-slip floor covering to ensure the utmost safety when working at height. Platform equipped with overload sensor and rack with a practical anti-shock system which ensures smooth, even rotational movements when stopping and starting movement. Equipped with a practical, efficient extension system allowing you to gain one metre per side. Equipped with practical fork slots for movement during storage.

REMOTE CONTROL REQUIRED

**Suitable for  
RTH - TH**

### REP 2-4,5

500 kg	2,350 - 4,530 x 1,100 mm	+ / - 90°	3	✓



## EXTENDABLE ROTATING PLATFORM 5.5

ATT - 01 - 009 Q-FIT I



Extendable rotating platform with 500 kg maximum capacity, type approved to carry three persons. Galvanised, reinforced steel structure. Non-slip floor covering to ensure the utmost safety when working at height. Platform equipped with overload sensor and rack with a practical anti-shock system which ensures smooth, even rotational movements when stopping and starting movement. Equipped with a practical, efficient extension system allowing you to gain one and a half metres per side. Equipped with practical fork slots for movement during storage.

REMOTE CONTROL REQUIRED

**Suitable for RTH**

### REP 2-5.5

500 kg	2,050 - 5,480 mm	+ / - 90°	3	



## EXTENDABLE ROTATING PLATFORM 6.5

ATT - 01 - 011 Q-FIT I



Extendable rotating platform with 500 kg maximum capacity, type approved to carry three persons. Galvanised, reinforced steel structure. Non-slip floor covering to ensure the utmost safety when working at height. Platform equipped with overload sensor and rack with a practical anti-shock system which ensures smooth, even rotational movements when stopping and starting movement. Equipped with a practical, efficient extension system allowing you to gain two metres per side. Equipped with practical fork slots for movement during storage.

REMOTE CONTROL REQUIRED

**Suitable for RTH**

### REP 2-6.5

500 kg	2,420 - 6,530 mm	+ / - 90°	3	



## ROTATING PLATFORM FOR TUNNELS

ATT - 01 - 013 Q-FIT I

Special platform for use in tunnels, with a maximum capacity of 500 kg and type approved for three persons. Galvanised, reinforced steel structure. Non-slip floor covering to ensure the utmost safety when working at height. Equipped with integrated protection grille on the upper part of the basket to protect against falling debris. Equipped with rack with a practical anti-shock system which ensures smooth, even rotational movements when stopping and starting movement. Equipped with practical fork slots for movement during storage.

REMOTE CONTROL REQUIRED

**Suitable for**  
**RTH**

### CRP 5

500 kg	1,810 x 1,000 mm	+/- 90°hydraulic	3	

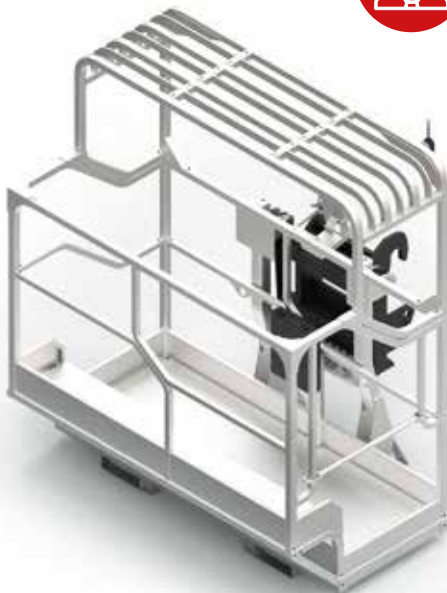

## MINING PLATFORM

ATT - 01 - 027 Q-FIT I

Special platform for use in mines, with a maximum capacity of 450 kg and type approved for two persons. Galvanised, reinforced steel structure. Non-slip floor covering to ensure the utmost safety when working at height. Equipped with integrated protection grille on the upper part of the basket to protect against falling debris. Equipped with practical fork slots for movement during storage. Equipped with anti-collision system that limits movements when the machine reaches a minimum safe distance from an obstacle.

REMOTE CONTROL REQUIRED

**Suitable for**  
**RTH - TH**

### CP 1,8

450 kg	1,800 x 1,000 mm	<b>X</b>	2	







## EXTENDABLE ROTATING PLATFORM + WINCH 600KG

**ATT - 01 - 026 Q-FIT I**

Extendable rotating platform with 500 kg maximum capacity, type approved to carry three persons. Galvanised, reinforced steel structure. Non-slip floor covering to ensure the utmost safety when working at height. Platform equipped with overload sensor and rack with a practical anti-shock system which ensures smooth, even rotational movements when stopping and starting movement. Equipped with a practical, efficient extension system allowing you to gain one metre per side. Equipped with practical fork slots for movement during storage. Equipped with a practical winch, 600 kg capacity. This can rotate +/- 90° manually, and lift 0-64°.

REMOTE CONTROL REQUIRED

**Suitable for  
RTH**

### REP 5.2-4,5 W0,6

500 kg	2,350 - 4,500 mm	+ / - 90°	3	600 kg	2,015 mm	+ / - 90° manual	0° /64°	49 m	✓



## EXTENDABLE ROTATING PLATFORM 1000 KG

**ATT - 01 - 016 Q-FIT I**

Extendable rotating platform with 1,000 kg maximum capacity, type approved to carry three persons. Galvanised, reinforced steel structure. Non-slip floor covering to ensure the utmost safety when working at height. Platform equipped with overload sensor and rack with a practical anti-shock system which ensures smooth, even rotational movements when stopping and starting movement. Equipped with a practical, efficient extension system allowing you to gain two metres per side. Equipped with practical fork slots for movement during storage.

REMOTE CONTROL REQUIRED

**Suitable for  
RTH - TH**

### REP 10.2-4,7

1,000 kg	2,350 - 4,700 mm	+ / - 90°	3	✓



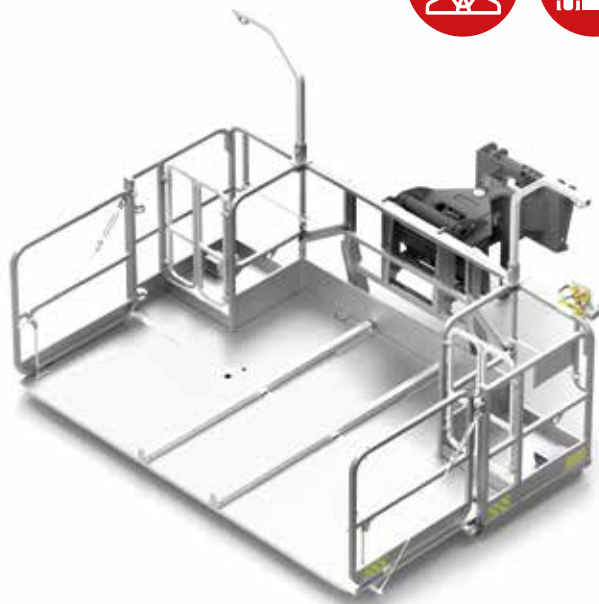

## EXTENDABLE ROTATING PLATFORM ASBESTOS 1000KG+FRONTAL OPENING

ATT - 01 - 018 Q-FIT I

Special platform dedicated to the removal of asbestos at height, with a capacity of up to 1,000 kg. Type approved for two persons. This is composed of two working stations equipped with deadman pedal on both and two anchor points, one low and one high, to allow egress at height. Non-slip floor covering to ensure the utmost safety when working at height. The front part tilts, allowing for easy offloading of materials. Platform equipped with overload sensor and rack with a practical anti-shock system which ensures smooth, even rotational movements when stopping and starting movement. Equipped with practical fork slots for movement during storage.

REMOTE CONTROL REQUIRED

**Suitable for RTH**

### RPRAB 10-3,5

1,000 kg	Open: 3.350 x 2,190 mm Close: 3.350 x 1,050 mm	+/- 90°hydraulic	2	

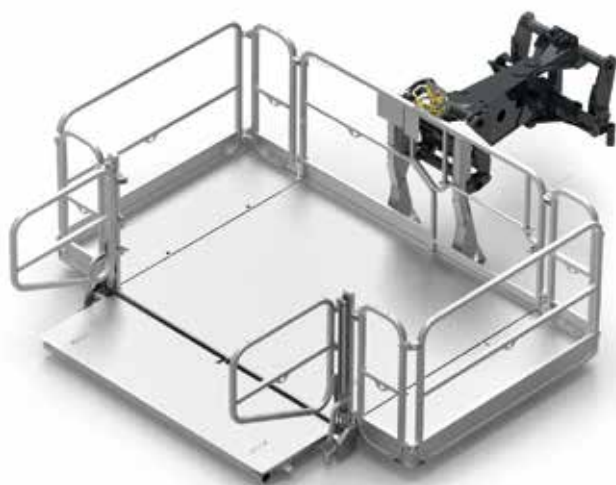

## EXTENDABLE ROTATING PLATFORM FOR ROOFS

ATT - 01 - 020 Q-FIT I

Extendable rotating platform with 1,000 kg maximum capacity, type approved to carry three persons and suitable for egress at height. This is composed of an openable guide which facilitates operator ingress/egress. The platform has sensors which disable movements with the basket open. Galvanised, reinforced steel structure. Non-slip floor covering to ensure the utmost safety when working at height. Platform equipped with overload sensor and rack with a practical anti-shock system which ensures smooth, even rotational movements when stopping and starting movement.

REMOTE CONTROL REQUIRED

**Suitable for RTH**

### RRP 10.2,5-3,5

1,000 kg	Open: 3,500 x 1,800 mm Closed: 2,500 x 1,800 mm	+/- 90° hydraulic	3	2,020 mm	740 mm	



## FIXED TELESCOPIC PLATFORM

ATT - 01 - 022 **Q-FIT I**

Extendable telescopic platform with 200 kg maximum capacity, type approved to carry two persons. Galvanised, reinforced steel structure. Non-slip floor covering to ensure the utmost safety when working at height. Rotation +/- 90° is made with an hydraulic actuator.



**⚠** REMOTE CONTROL REQUIRED

**Suitable for RTH**

### TP 2,10

200 kg	1,400 x 700 mm	+ / - 90°	2	6,430 - 10,200 mm	6,440 - 9,770 mm	3,330 mm	✓



## TELESCOPIC PLATFORM THAT CAN WORK EITHER POSITIVE OR NEGATIVE TP O/U

ATT - 01 - 024 **Q-FIT I**

Extendable rotating telescopic platform with a maximum capacity of 200 kg. It is type approved to carry two persons. Galvanised, reinforced steel structure. Non-slip floor covering to ensure the utmost safety when working at height. Equipped with boom position sensor, which can be easily consulted on the display in the cab. Rotation 340° is made with an hydraulic actuator.



**⚠** REMOTE CONTROL REQUIRED

**Suitable for RTH**

### TP O-U

200 kg	1,240 x 800 mm	340° hydraulic	2	5,100 - 6,900 mm	4,975 - 6,705 mm	6,350 - 8,080 mm	1,800 mm	✓

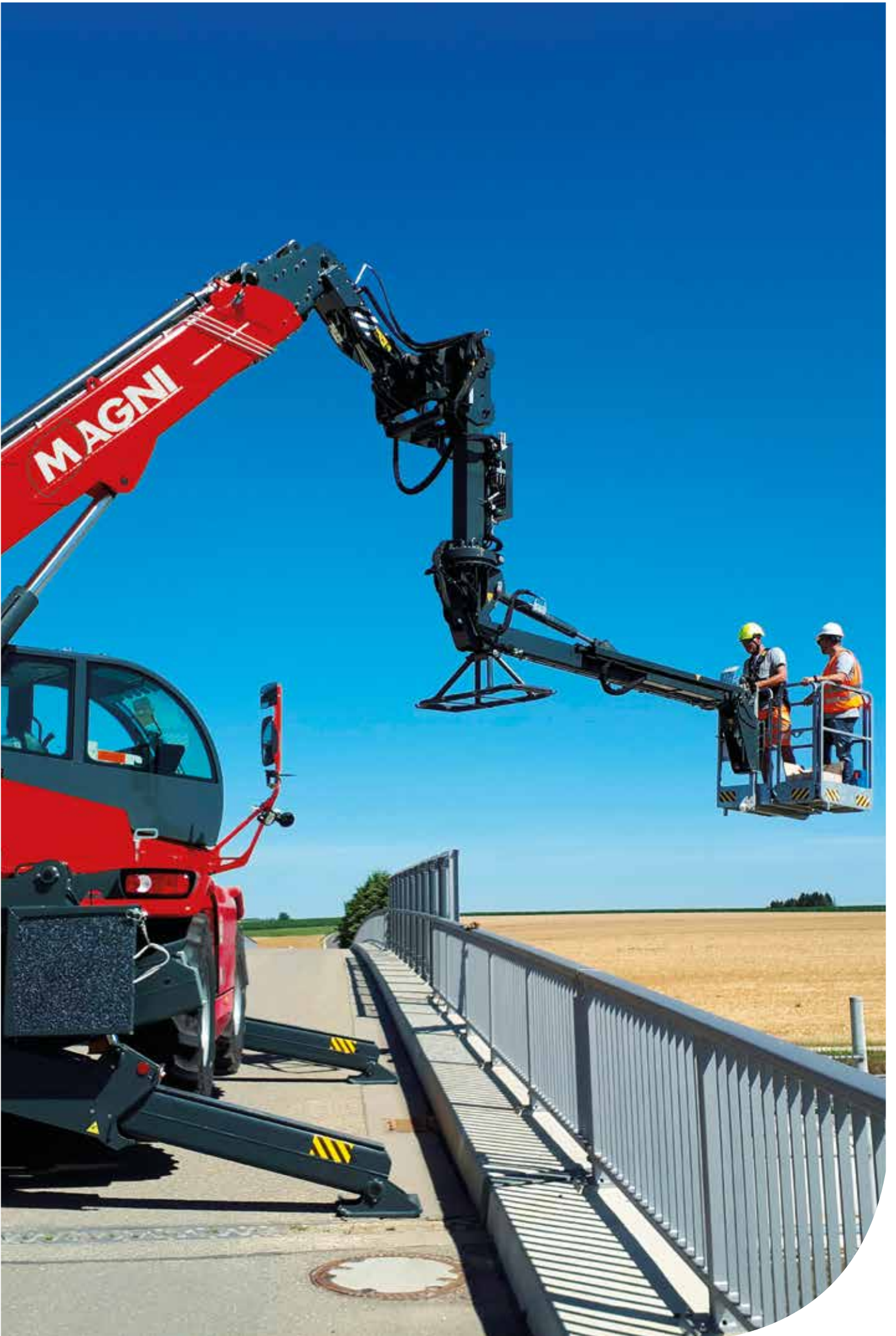

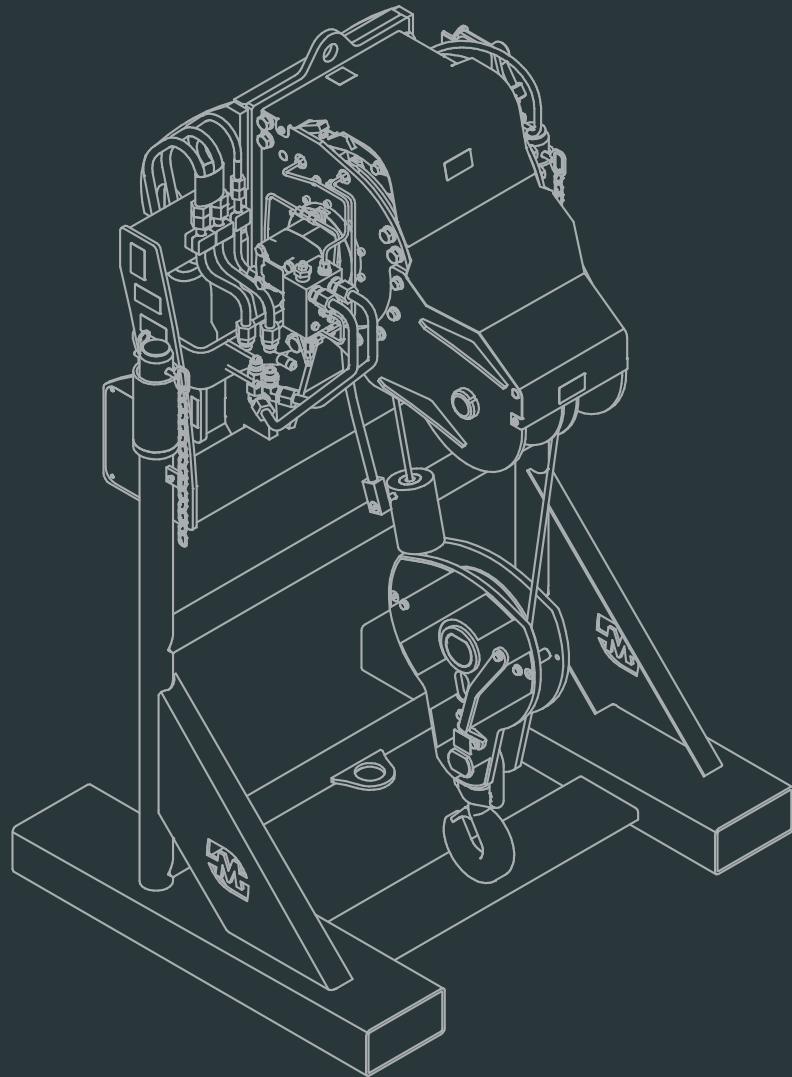

---

# WINCHES

To effortlessly lift and move objects, more or less bulky, making the most of your Magni's performance, our range of winches is the ideal solution. Compact, sturdy, they are top quality accessories, which bear Magni's constructive signature in every design detail.

**Warning:**

Compatibility depends also on the max capacity of the unit. please check max allowed weight. if in doubt, ask.







## WINCH 2,700KG

*ATT - 02 - 001 Q-FIT I*

Winch with swivelling type-approved hook with 2,700 kg capacity. Attachment equipped with rope pressure roller and hydraulic limit switch system for rope raising/lowering. Metal storage support included in code.

**Suitable for  
RTH - TH**

**W2,7**

				
2,700 kg	10 mm	25 m	24 m/min	✓







## WINCH 3,500KG

*ATT - 02 - 002 Q-FIT I*

Winch with swivelling type-approved hook with 3,500 kg capacity. Attachment equipped with rope pressure roller and hydraulic limit switch system for rope raising/lowering. Metal storage support included in code.

**Suitable for  
RTH - TH**

**W3,5**

				
3,500 kg	10 mm	25 m	24 m/min	✓



## WINCH 5,000KG

ATT - 02 - 019 Q-FIT I

Winch with swivelling type-approved hook with 5,000 kg capacity. Attachment equipped with rope pressure roller and hydraulic limit switch system for rope raising/lowering. Metal storage support included in code.



**Suitable for**  
RTH - TH

W6

5,000 kg	12 mm	27 m	19 m/min	✓



## WINCH 6,000KG

ATT - 02 - 004 Q-FIT I

Winch with swivelling type-approved hook with 6,000 kg capacity. Attachment equipped with rope pressure roller and hydraulic limit switch system for rope raising/lowering. Metal storage support included in code.



**Suitable for**  
RTH - HTH 10.10 - TH

W6

6,000 kg	12 mm	27 m	19 m/min	✓







## WINCH 8,000KG

ATT - 02 - 006 Q-FIT I

Winch with swivelling type-approved hook with 8,000 kg capacity. Attachment equipped with rope pressure roller and hydraulic limit switch system for rope raising/lowering. Metal storage support included in code.

**Suitable for**  
**RTH**

### W8

				
8,000 kg	16 mm	40 m	13 m/min	✓







## WINCH 16,000KG

ATT - 02 - 008 Q-FIT I

Winch with swivelling type-approved hook with 16,000 kg capacity. Attachment equipped with rope pressure roller and hydraulic limit switch system for rope raising/lowering. Metal storage support included in code.

**Suitable for**  
**HTH** (no HTH 10.10)

### W16

				
16,000 kg	16 mm	20 m	10 m/min	✓









## WINCH 3,500KG/1,750KG

ATT - 02 - 009 Q-FIT I

Winch with swivelling type-approved hook, which can be configured to two capacities: 3,500 kg dual and 1,750 kg single. Attachment equipped with rope pressure roller and hydraulic limit switch system for rope raising/lowering. Metal storage support included in code.

**Suitable for**  
RTH - TH

W 3,5 - 1,75

				
1,750 / 3,500 kg	10 mm	50/25 m	48/24 m/min	✓







## WINCH 3,000KG/6,000KG

ATT - 02 - 010 Q-FIT I

Winch with swivelling type-approved hook, which can be configured to two capacities: 6,000 kg dual and 3,000 kg single. Attachment equipped with rope pressure roller and hydraulic limit switch system for rope raising/lowering. Metal storage support included in code.

**Suitable for**  
RTH - TH

W 3 - 6

				
3,000 / 6,000 kg	12 mm	58/26 m	32/16 m/min	✓







## WINCH 13,000KG

ATT - 02 - 018 **Q-FIT I**

Winch with swivelling type-approved hook with 13,000 kg capacity. Attachment equipped with rope pressure roller and hydraulic limit switch system for rope raising/lowering. Metal storage support included in code.

**Suitable for  
RTH**

### W13

				
13,000 kg	16 mm	26 m	8 m/min	✓



## WINCH FITTED AT THE BASE OF THE BOOM 6T

ATT - 02 - 013 **Q-FIT I**

Winch with swivelling type-approved hook, which can be configured to two capacities: 6,000 kg dual and 3,000 kg single. Attachment equipped with rope pressure roller and hydraulic limit switch system for rope raising/lowering. Metal storage support included in code. Improved performance compared to the W6 thanks to the configuration of the attachment itself, which has the drum on the boom and not directly fastened to the winch.

**Suitable for  
RTH 6.30**

### WB6

				
3,000/6,000 kg	12 mm	85 m (single pull 3 ton) / 42.5 m (double pull 6 ton)	32 m/min (single pull) / 17 m/min (double pull)	✓



## WINCH FITTED AT THE BASE OF THE BOOM 6T ARTICULATED FOR ROAD CIRCULATION

ATT - 02 - 014 Q-FIT I

Winch with joint which allows it to be tilted back to allow use on roads. Winch with swivelling type-approved hook, which can be configured to two capacities: 6,000 kg dual and 3,000 kg single. Attachment equipped with rope pressure roller and hydraulic limit switch system for rope raising/lowering. Metal storage support included in code. Improved performance compared to the W6 thanks to the configuration of the attachment itself, which has the drum on the boom and not directly fastened to the winch.

**Suitable for**  
**RTH 6.30**



### AWB6

				
3,000/6,000 kg	12 mm	85 m (single pull 3 ton) / 42.5 m (double pull 6 ton)	32 m/min (single pull) / 17 m/min (double pull)	✓



## WINCH FITTED AT THE BASE OF THE BOOM 6T



ATT - 02 - 016 Q-FIT I

Winch with swivelling type-approved hook, which can be configured to two capacities: 6,000 kg dual and 3,000 kg single. Attachment equipped with rope pressure roller and hydraulic limit switch system for rope raising/lowering. Metal storage support included in code. Improved performance compared to the W6 thanks to the configuration of the attachment itself, which has the drum on the boom and not directly fastened to the winch.

**Suitable for**  
**RTH 6.35 / 6.39**



### WB6

				
3,000/6,000 kg	12 mm	85 m (single pull 3 ton) / 42.5 m (double pull 6 ton)	32 m/min (single pull) / 17 m/min (double pull)	✓







---

# FORK CARRIAGES

Wide range to meet market needs and to assist our operators directly in the workplace. From the simplest fork carriers to those with heavy-duty capacities and larger fork sizes to be able to perform aggravating work in the most extreme conditions.

**Warning:**

Compatibility depends also on the max capacity of the unit. please check max allowed weight. if in doubt, ask.



## STANDARD FORK CARRIAGE 5T

ATT - 03 - 001 Q-FIT I

Floating fork carriage with 5,000 kg capacity.



**Suitable for**  
RTH

### FC5T

5,000 kg	1,200 mm	586 mm (min) - 1,040 mm (max)	✗	✓



## FEM FORK CARRIAGE 5T

ATT - 03 - 003 Q-FIT I

Fork carriage with fork attachment plate, 5,000 kg capacity, 1,300 mm width



**Suitable for**  
RTH  
NO ANSI

### FCF5T 1,3

5,000 kg	1,200 mm	260 mm (min) - 1,300 mm (max)	✗	✗	✓





## GRID FOR LOAD PROTECTION FOR FEM AND FLOATING FORK CARRIAGE



ATT - 03 - 005

ATT - 03 - 041

Upper support and protection grille for FEM and floating fork carriage.

**Suitable for  
RTH - TH**

PCF



1,140 x 500 mm



## GRID FOR LOAD PROTECTION FOR STD FORK CARRIAGE



ATT - 03 - 038

Upper support and protection grille for fork carriage.

**Suitable for  
RTH - TH**

PC



1,070 x 356 mm



## STANDARD FORK CARRIAGE 5T

ATT - 03 - 039 Q-FIT I

Floating forks with 5,000 kg capacity.



**Suitable for  
TH**

### FC5T FIX

5,000 kg	1,200 mm	440 mm (min) - 1,040 mm (max)	✗	✓



## STANDARD FORK CARRIAGE 5.5T

ATT - 03 - 040 Q-FIT I

Floating forks with 5,500 kg capacity.



**Suitable for  
TH**

### FC5T FIX

5,500 kg	1,200 mm	440 mm (min) - 1,040 mm (max)	✗	✓



## STANDARD FORK CARRIAGE 6T

ATT - 03 - 006 Q-FIT I

Floating fork carriage with 6,000 kg capacity.



**Suitable for  
RTH**

### FC6T

6,000 kg	1,200 mm	456 mm (min) - 1,040 mm (max)	✗	✓



## STANDARD FORK CARRIAGE 6T

ATT - 03 - 008 Q-FIT I

Floating fork carriage with 6,000 kg capacity, dedicated for model RTH 6.46.



**Suitable for  
RTH 6.46**

### FC6T

6,000 kg	1,200 mm	580 mm (min) - 1,040 mm (max)	✗	✓



## FORK CARRIAGE 6T

ATT - 03 - 009 Q-FIT I

Floating fork carriage with 6.000 kg capacity, increased width of 1,840 mm and minimum closure 1,550 mm.



**Suitable for**  
RTH

FC6T 6x5 FT

6,000 kg	1,550 mm	740 mm (min) - 1,840 mm (max)	×	×	✓



## FEM FORK CARRIAGE 6T

ATT - 03 - 010 Q-FIT I

Forks with fork attachment plate, 6,000 kg capacity, 1,320 mm width and 1,200 mm fork length.



**Suitable for**  
RTH - TH

FCF6T 1,3

6,000 kg	1,200 mm	280 mm (min) - 1,310 mm (max)	×	×	✓



## STANDARD FORK CARRIAGE 6T

ATT - 03 - 012 Q-FIT I

Floating forks with 6,000 kg capacity.



**Suitable for  
TH**

### FC6T FIX

6,000 kg	1,200 mm	780 mm (min) - 1,040 mm (max)	✗	✓



## WIDE FORK CARRIAGE 6T

ATT - 03 - 014 Q-FIT I

Floating forks with 6,000 kg capacity, dedicated for the TH range.



**Suitable for  
RTH - TH**

### FC6T 72x72 FIX

6,000 kg	1,830 mm	700 mm (min) - 1,840 mm (max)	✗	✓



## STANDARD FORK CARRIAGE 8T

ATT - 03 - 015 Q-FIT I

Floating forks with 8,000 kg capacity.



**Suitable for  
RTH**

FC8T

8,000 kg	1,200 mm	580 mm (min) - 1,040 mm (max)	×	×	✓



## WIDE FORK CARRIAGE 8T

ATT - 03 - 017 Q-FIT I

Floating fork carriage with 8,000 kg capacity, fork width 1,840 and fork length 1,830 mm.



**Suitable for  
RTH**

FC8T 72x72

8,000 kg	1,830 mm	580 mm (min) - 1,840 mm (max)	×	✓



## FORK CARRIAGE 10T





ATT - 03 - 018 Q-FIT I

Floating fork carriage with capacity up to 10,000 kg, with load protection grid.



**Suitable for  
HTH 10.10**

### F10T

				
10,000 kg	1,500 mm	min 810 mm	max 1,750 mm	✓



## FORK CARRIAGE 10T (WITH FORK POSITIONER)

ATT - 03 - 019 Q-FIT I

Floating fork carriage with capacity up to 10,000 kg, with hydraulic movement of the individual forks possible.



**Suitable for  
HTH 10.10**

### FCP10T

				
10,000 kg	1,500 mm	min 820 mm	max 1,740 mm	✓









## FORK CARRIAGE 10T (WITH FORK POSITIONER)

ATT - 03 - 020 *Q-FIT I*

Fork carriage with capacity up to 10,000 kg, with hydraulic movement of the individual forks possible. Equipped with 2,500 mm long, 2,300 mm wide forks. Load protection grid included.



**Suitable for  
HTH 10.10**

### FCP10T 2,5 C

				
10,000 kg	2,500 mm	min 820 mm	max 2.310 mm	



## FORK CARRIAGE 13T (WITH FORK POSITIONER)





ATT - 03 - 021 *Q-FIT I*

Floating fork carriage with capacity up to 13,000 kg.



**Suitable for  
RTH**

### FCP13T

				
13,000 kg	1,500 mm	min 850 mm	max 1,780 mm	



## FORK CARRIAGE 16T

ATT - 03 - 022 *Q-FIT I*

Floating fork carriage with capacity up to 16,000 kg.



**Suitable for  
HTH**

### F16T

16,000 kg	1,500 mm	1,130 mm	2,000 mm	✓



## FORK CARRIAGE 16T (WITH FORK POSITIONER)

ATT - 03 - 023 *Q-FIT I*

Floating fork carriage with capacity up to 16,000 kg, with hydraulic movement of the individual forks possible. Load protection grid included.



**Suitable for  
HTH**

### FCP16T

16,000 kg	1,500 mm	1,160 mm	2,000 mm	✓



## FORK CARRIAGE 16T (WITH FORK POSITIONER AND SIDE SHIFT)







ATT - 03 - 024 Q-FIT I

Floating fork carriage with capacity up to 16,000 kg, with hydraulic movement of the individual forks and combined side shift possible. Load protection grid included.



**Suitable for  
HTH**

FCPT16 2,4

				SIDE SHIFT	
16,000 kg	2,400 mm	min 570 mm	max 1,995 mm	+/- 300 mm	



## FORK CARRIAGE 16T (WITH FORK POSITIONER)







ATT - 03 - 025 Q-FIT I

Floating ork carriage with 2,300 mm width and capacity up to 10,000 kg, with hydraulic movement of the individual forks possible. Load protection grid included.



**Suitable for  
HTH**

FCP16T C

				
16,000 kg	2,400 mm	2,300 mm	1,268 - 2,300 mm	



## FORK CARRIAGE 20T (WITH FORK POSITIONER)

ATT - 03 - 026 Q-FIT I

Floating fork carriage with capacity up to 20,000 kg, with hydraulic movement of the individual forks possible. Load protection grid included.



**Suitable for  
HTH**

### FCP20T

20,000 kg	1,500 mm	1,160 mm	2,000 mm	✓



## FORK CARRIAGE 24T (WITH FORK POSITIONER)

ATT - 03 - 027 Q-FIT I

Floating fork carriage with capacity up to 24,000 kg, with hydraulic movement of the individual forks possible. Load protection grid included.



**Suitable for  
HTH**

### FCP24T

24,000 kg	1,800 mm	1,250 mm	1,990 mm	✓



## FORK CARRIAGE 24T (WITH FORK POSITIONER)

*ATT - 03 - 028 Q-FIT I*

Floating fork carriage with capacity up to 24,000 kg. Fork width 2,315 mm, fork length 2,400 mm. Hydraulic movement of the individual forks possible. Load protection grid included.



**Suitable for  
HTH**

**FCP24T 2,4**

				
24,000 kg	2,400 mm	2,315 mm	1,235 mm	✓



## FORK CARRIAGE 27T (WITH FORK POSITIONER)





*ATT - 03 - 029 Q-FIT I*

Floating fork carriage with capacity up to 27,000 kg. Fork width 2,500 mm, fork length 2,400 mm. Hydraulic movement of the individual forks possible. Load protection grid included.



**Suitable for  
HTH**

**FCP27T**

				
27,000 kg	2,400 mm	1,430 mm	2,400 mm	✓



## FORK CARRIAGE 30T (WITH FORK POSITIONER)

ATT - 03 - 030 Q-FIT I

Floating fork carriage with capacity up to 30,000 kg. Fork width 2,500 mm, fork length 2,400 mm. Hydraulic movement of the individual forks possible. Load protection grid included.



**Suitable for  
HTH**

### FCP30T

30,000 kg	2,400 mm	min 1,360 mm	max 1,990 mm	✓



## FORK CARRIAGE 30T (WITH FORK POSITIONER AND SIDESHIFT)

ATT - 03 - 031 Q-FIT I

Lowered fork carriage with capacity up to 30,000 kg, with hydraulic movement of the individual forks and combined side shift possible. Thinner forks and without load protection and support grille.



**Suitable for  
HTH**

### FCPT30T 2,4 R

				SIDE SHIFT	
30,000 kg	2,400 mm	min 830 mm	max 2,650 mm	+/- 300 mm	✓



## EXTENDABLE 30T FORK CARRIAGE WITH POSITIONER

ATT - 03 - 032 Q-FIT I

Lowered fork carriage with capacity up to 30,000 kg, with hydraulic movement of the individual forks possible.



**Suitable for  
HTH**

FCEP30T 2,4 R

				
30,000 kg	2,400 mm	1,360 mm	max 2,500 mm	✓



## FORK CARRIAGE 35T (WITH POSITIONER)





ATT - 03 - 033 Q-FIT I

Fork carriage with capacity up to 35,000 kg, with hydraulic movement of the individual forks possible.



**Suitable for  
HTH**

FCP35T

				
35,000 kg	2,400 mm	min 1,400 mm	max 2,030 mm	✓





## FORK CARRIAGE 50T (WITH POSITIONER)







ATT - 03 - 037 Q-FIT I

Fork carriage with capacity up to 50,000 kg, with hydraulic movement of the individual forks. Load protection grid included.



**Suitable for  
HTH**

### FCP50T

				
50,000 kg	2,400 mm	1,400 mm	2,030 mm	



---

# JIB WITH & WITHOUT WINCH

Accessories that are widely used because they are highly versatile and performing, both from a lifting capacity point of view and for the wide choice of capacities offered. As always, Magni has designed a range of accessories specific to market demands, which can be used with every Magni in the catalog.

**Warning:**  
Compatibility depends also on the max capacity of the unit. please check max allowed weight. if in doubt, ask.





## JIB 600KG

ATT - 04 - 001 **Q-FIT I**

Fixed-hook jib which increases reach by a further 4 metres. Tubular structure to improve the weight/capacity ratio.



**Adatto per**  
**RTH - TH**

J600		
		
600 kg	4,000 mm	✓









## JIB 800KG FOR WINCH AT THE LOWER END OF THE BOOM

ATT - 04 - 003 **Q-FIT I**

Specific jib for machine equipped with winch at the base of the boom. Tubular structure to improve the weight/capacity ratio and to increase the working range. Winch at the lower end of the boom is not included and must be ordered separately.



**Suitable for**  
**RTH 6.30 / 6.35**

JV 800					
					
800 kg	7,200 mm	12 mm	77 m	16 m/min	✓



## JIB WITH WINCH 800KG







ATT - 04 - 005 Q-FIT I

Jib, length 7 metres, with integrated winch on attachment. Tubular structure to improve the weight/capacity ratio. Winch equipped with rope pressure roller and hydraulic limit switch system for rope raising/lowering.



**Suitable for  
RTH**

### JW800

					
800 kg	7,100 mm	10 mm	24/44 m	48/24 m/min	✓



## JIB WITH WINCH 800/1,500 KG





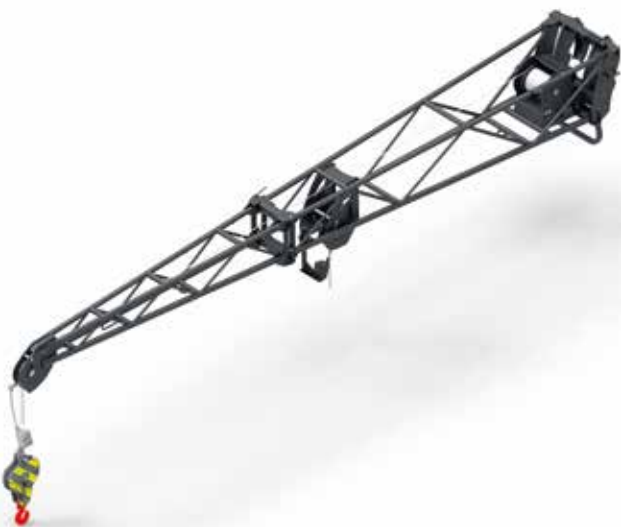

ATT - 04 - 007 Q-FIT I

Jib with integrated winch on attachment which can be folded and configured for two capacities. Fully extended, with length of 7 metres, it has a single capacity of 800 kg; folded, with 3.3 metre length, it has a dual capacity of 1,500 kg. Winch equipped with rope pressure roller and hydraulic limit switch system for rope raising/lowering.



**Suitable for  
RTH**

### JW 800/1500

					
800/1,500 kg	7,100 / 3,300 mm	10 mm	44/24 m	48/24 m/min	✓



## JIB WITH WINCH 1,200/3,000KG

ATT - 04 - 009 Q-FIT I

Jib with integrated winch on attachment which can be folded and configured for two capacities. Fully extended, with length of 4.5 metres, it has a single capacity of 1,200 kg; folded, with 1.6 metre length, it has a dual capacity of 3,000 kg. Winch equipped with rope pressure roller and hydraulic limit switch system for rope raising/lowering.



**Suitable for**  
RTH - TH

### JW1200/3000

1,200/3,000 kg	4,500 / 1,600 mm	10 mm	48/25 m	48/24 m/min	✓



## JIB WITH WINCH 1,500KG

ATT - 04 - 011 Q-FIT I

Jib with integrated winch on attachment, capacity 1,500 kg and length 2 metres. Tubular structure to improve the weight/capacity ratio. Winch equipped with rope pressure roller and hydraulic limit switch system for rope raising/lowering.



**Suitable for**  
RTH - TH

### JW 1500

1,500 kg	2,200 mm	10 mm	24 m	24 m/min	✓





## JIB 2,000KG

ATT - 04 - 013 Q-FIT I

Dual T-section beam with fixed hook, capacity 2,000 kg and length 2.7 metres

**Suitable for**  
RTH - HTH 10.10 -TH



J2000					
2,000 kg	2,700 mm	✓			



## JIB WITH WINCH 2,000KG

ATT - 04 - 015 Q-FIT I

Jib with integrated winch on attachment, capacity 2,000 kg and length 2 metres. Tubular structure to improve the weight/capacity ratio. Winch equipped with rope pressure roller and hydraulic limit switch system for rope raising/lowering.

**Suitable for**  
RTH - TH



JW 2000					
2,000 kg	2,150 mm	10 mm	24 m	24 m/min	✓





## JIB WITH WINCH 2,700KG

ATT - 04 - 017 Q-FIT I

Jib with integrated winch on attachment, capacity 2,700 kg and length 1.7 metres. Tubular structure to improve the weight/capacity ratio. Winch equipped with rope pressure roller and hydraulic limit switch system for rope raising/lowering.



**Suitable for**  
RTH - TH

### JW2700

2,700 kg	1,700 mm	12 mm	50 m	30 m/min	✓





## JIB WITH WINCH 3,000KG

ATT - 04 - 019 Q-FIT I

Jib with integrated winch on attachment, capacity 3,000 kg and length 1.7 metres. Tubular structure to improve the weight/capacity ratio. Winch equipped with rope pressure roller and hydraulic limit switch system for rope raising/lowering.



**Suitable for**  
RTH - TH

### JW 3000

KG	1,700 mm	12 mm	50 m	30 m/min	M R.F.I.D. ✓
3,000 kg	1,700 mm	12 mm	50 m	30 m/min	✓



## TELESCOPIC JIB 2,500/1,500KG

ATT - 04 - 021 Q-FIT I

Telescopic box-section jib with fixed hook. Two capacities: fully retracted 2,500 kg at 1,800 mm; extended 1,500 kg at 2,700 mm, with travel of 900 mm.



**Suitable for**  
RTH - TH

### JT2500

KG	1,790 mm (closed) - 2,690 mm (openes)	900 mm	M R.F.I.D. ✓
2,500 kg (closed) - 1,500 kg (opened)	1,790 mm (closed) - 2,690 mm (openes)	900 mm	✓



## 3,000KG "SWAN NECK" JIB



ATT - 04 - 023 Q-FIT I

Swan-neck jib with 3,000 kg capacity, ideal for working in confined spaces and under roof, overhangs and greenhouses.



**Suitable for  
RTH - TH**

### JCC3000

			
3,000 kg	1,500 mm	1,077 mm	✓







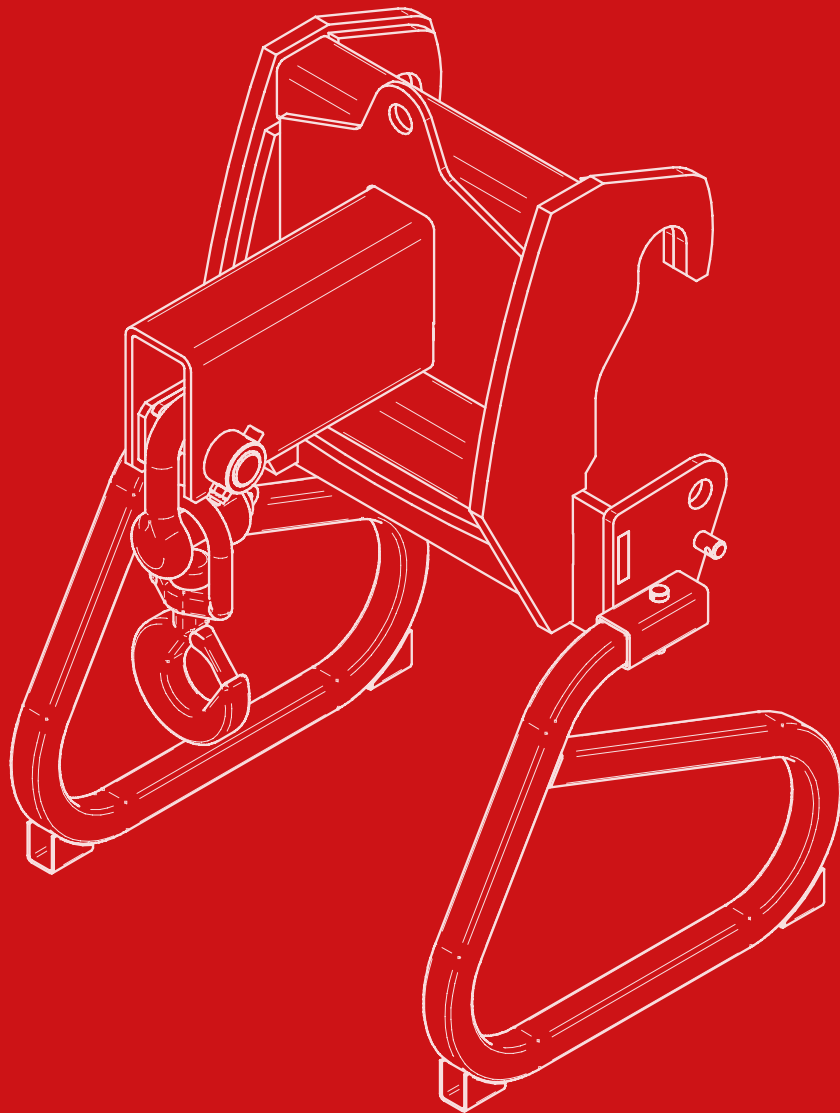

---

# HOOKS

Simple but extremely versatile and resistant, Magni approved hooks offer a wide solution for use in the construction world. The range consists of hooks of different capacities to meet the specific needs of the market and to be able to work with all the machine models offered.

**Warning:**

Compatibility depends also on the max capacity of the unit. please check max allowed weight. if in doubt, ask.



## HOOK 5T

ATT - 05 - 014 Q-FIT I

Type-approved hook for swivel lifting with latch, high-strength alloy steel. Capacity up to 6,000 kg. Metal storage support included in code.



**Suitable for**  
RTH - TH

### H6

			
5,000 kg	500 mm	✓	✓



## HOOK 6T

ATT - 05 - 001 Q-FIT I

Type-approved hook for swivel lifting with latch, high-strength alloy steel. Capacity up to 6,000 kg. Metal storage support included in code.



**Suitable for**  
RTH - HTH 10.10 - TH

### H6

			
6,000 kg	500 mm	✓	✓





## HOOK 8T

ATT - 05 - 003 *Q-FIT I*

Type-approved hook for swivel lifting with latch, high-strength alloy steel. Capacity up to 8,000 kg  
Metal storage support included in code.

**Suitable for  
RTH**

H8

			
8,000 kg	1,102 mm	✓	✓



## HOOK 10T

ATT - 05 - 005 *Q-FIT I*

Type-approved hook for swivel lifting with latch, high-strength alloy steel. Capacity up to 10,000 kg  
Metal storage support included in code.

**Suitable for  
RTH - HTH 10.10**

H10

			
10,000 kg	500 mm	✓	✓



## HOOK 13T

ATT - 05 - 013 Q-FIT I

Type-approved hook for swivel lifting with latch, high-strength alloy steel. Capacity up to 13,000 kg. Compact design to increase performance during loading in terms of the stability of the load.

**Suitable for**  
**RTH**

### H13

			
13,000 kg	297 mm	✓	✓



## HOOK 16T

ATT - 05 - 007 Q-FIT I

Type-approved hook for swivel lifting with latch, high-strength alloy steel. Capacity up to 16,000 kg. Metal storage support included in code. Compact design to increase performance during loading in terms of the stability of the load.

**Suitable for**  
**HTH**

### H16S

			
16,000 kg	350 mm	✓	✓



## HOOK 20T

ATT - 05 - 008 Q-FIT I

Type-approved hook for swivel lifting with latch, high-strength alloy steel. Capacity up to 20,000 kg. Metal storage support included in code. Compact design to increase performance during loading in terms of the stability of the load.



**Suitable for  
HTH**

### H20S

			
20,000 kg	350 mm		





## HOOK 30T



ATT - 05 - 009 Q-FIT I

Oscillating lifting hook to facilitate load positioning. Capacity up to 30,000 kg. Compact design to increase performance during loading in terms of the stability of the load.



**Suitable for  
HTH**

### H30S

			
30,000 kg	400 mm	+/- 30°	✓



## SHORT HOOK 40T

ATT - 05 - 011 Q-FIT I

Oscillating lifting hook to facilitate load positioning. Capacity up to 40,000 kg. Compact design to increase performance during loading in terms of the stability of the load.



**Suitable for  
HTH**

### H40S

			
40,000 kg	400 mm	+/- 30°	✓



## HOOK 50T

ATT - 05 - 012 Q-FIT I

Oscillating lifting hook to facilitate load positioning. Capacity up to 50,000 kg. Compact design to increase performance during loading in terms of the stability of the load.



**Suitable for  
HTH**

### H50

			
50,000 kg	760 mm	+/- 30°	✓



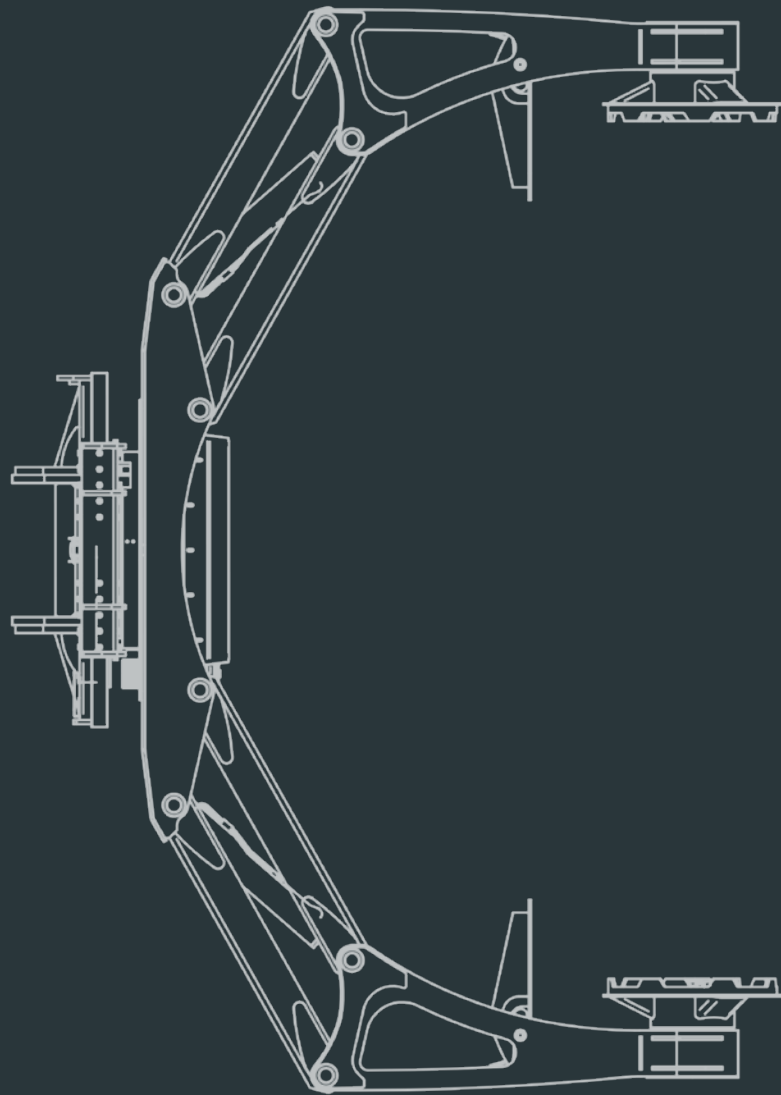

---

# CLAMPS

Very specific accessories designed on stringent needs felt above all in the mining and extractive sector, and lately also of recycling. This is a range of accessories designed for changing tires of large truck dumpers used in the mine, capable of adapting to the performance of each Magni sold in the market.

**Warning:**

Compatibility depends also on the max capacity of the unit. please check max allowed weight. if in doubt, ask.



## RIB HANDLER 4T

ATT - 06 - 001 Q-FIT I

Clamp made of high-strength material for positioning the ribs comprising the supporting arches for tunnel construction.

**Suitable for**  
RTH

### RC 4T

4,000 kg	46°	+/- 65° (manual)	✓

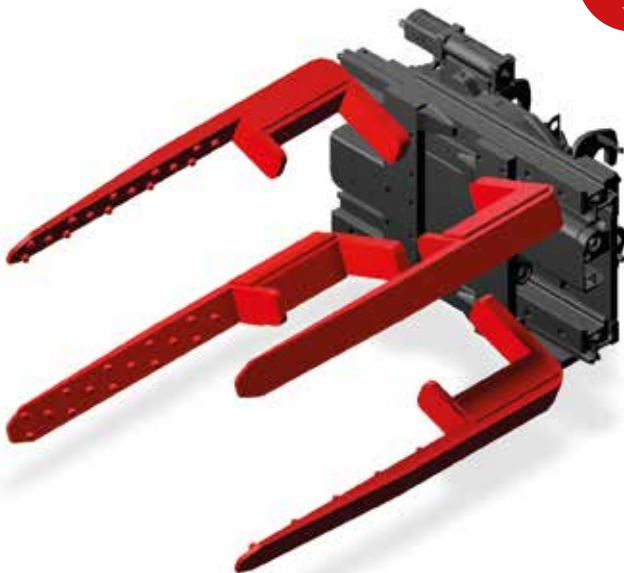

## TYRE HANDLER 2.5T

ATT - 06 - 003 Q-FIT I

Tyre clamp, 2,500 kg capacity, for 25" tyres. Hydraulic opening/closing.

**OPT-02-022** DOUBLE HYDRAULIC OUTPUT AT THE BOOM HEAD IS MANDATORY

**Suitable for**  
RTH - HTH 10.10 - TH

### TC2,5.25

2,500 kg	1,220 mm	2,350 mm	360°	✗	✓







## TYRE HANDLER 3.5T

ATT - 06 - 004 Q-FIT I

Tyre clamp, 3,500 kg capacity, for 35" tyres. Hydraulic opening/closing. Clamp rotation (clockwise/anticlockwise): +/- 24°; tyre rotation +/- 61°.



**Suitable for**  
HTH 10.10 - TH 6.20

**TC3,5**

3,500 kg	1,120 mm	3,500 mm	+/- 24°	+/-61°	✓



## TYRE HANDLER 3.8T

ATT - 06 - 005 Q-FIT I

Tyre clamp, 3,800 kg capacity, for 49" tyres. Hydraulic opening/closing and 360° rotation.

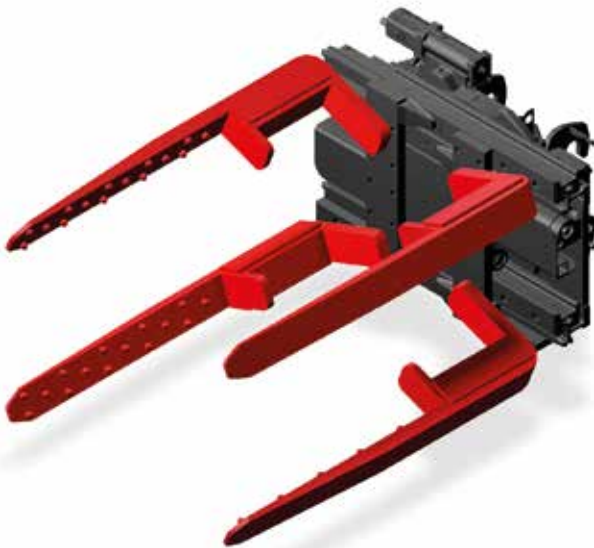

**OPT-02-022** DOUBLE HYDRAULIC OUTPUT AT THE BOOM HEAD IS MANDATORY

**Suitable for**  
RTH - HTH 10.10 - TH 6.20

**TC3,8.49**

3,800 kg	1,210 mm	3,130 mm	360°	✗	✓



## TYRE HANDLER 8T

ATT - 06 - 006 Q-FIT I

Tyre clamp, 8,000 kg capacity, for 63" tyres. Hydraulic opening/closing movement, 360° tyre rotation, +/- 300 mm lateral clamp movement, 344° clockwise/anticlockwise clamp rotation.



Suitable for  
HTH

### TC08.63

8,000 kg	1,180 mm	4,000 mm	344° (+165°/-179°)	360°	+/- 300 mm	✓



## TYRE HANDLER 16T

ATT - 06 - 007 Q-FIT I

Tyre clamp, 16,000 kg capacity, for 63" tyres. Hydraulic opening/closing movement, 360° rotation, +/- 300 mm lateral clamp movement, 344° clockwise/anticlockwise clamp rotation. Tyre rotation of 360° performed via chains to provide additional safety.



Suitable for  
HTH

### TC16.63 CP

16,000 kg	1,170 mm	4,250 mm	344° (+165°/-179°)	360°	+/- 300 mm	✓

## DEMOLITION GRAB

ATT - 06 - 008 Q-FIT I



Clamp used for primary demolition of reinforced concrete. The continuous hydraulic rotation facilitates positioning of the equipment, while the robust dual ball race slewing bearing ensures strength and increases safety. The cylinders develop enormous force which is then increased and transferred to the jaws (even completely open) by a unique mechanism. The special teeth profile maximises penetration, keeping the tips sharp for longer. The patented Speed-Valve increases productivity and protects the hydraulic system from peaks of pressure.

**OPT-02-022** DOUBLE HYDRAULIC OUTPUT AT THE BOOM HEAD IS MANDATORY

**OPT-03-005** MANDATORY PROTECTION GRID FOR WINDSCHIELD

**Suitable for**  
RTH - HTH 10.10 - TH

### PD CR5

			
2,000 kg	450 mm	360°	✓



## PIPES HANDLER 1,000 KG







ATT - 06 - 009 Q-FIT I



Clamp designed to move pipes, load capacity up to 1,000 kg, min.  $\varnothing$  242 mm and max. 580 mm. The clamp has three degrees of freedom; 360° rotation, side shift and clamps opening/closing.

**Suitable for**  
RTH - HTH 10.10 - TH

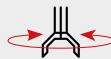
### PC 1000

					
1,000 kg	242 mm	580 mm	+/- 150 mm	360°	✓



## CYLINDER HANDLER 11T

ATT - 06 - 010 Q-FIT I

Clamp for the maintenance, replacement and movement of large excavator cylinders up to 11,000 kg and max  $\varnothing$  620 mm. This attachment must be installed with MTM, which must be ordered separately.

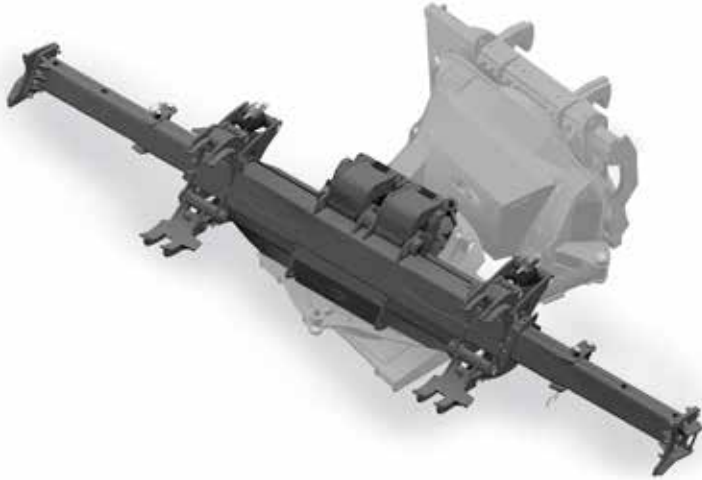

**⚠ ATT-08-004** MULTITOOL - HANDLER FOR MULTIPLE ATTACHMENTS IS MANDATORY

**Suitable for  
HTH**

CC

11,000 kg	2,960 - 960 mm	5,800 mm (max) 2,760 mm (min)	620 mm	+/- 300 mm	360°	✓



## CYLINDER HANDLER 4.5T

ATT - 06 - 011 RTH - HTH 10.10 - TH 6.20

ATT - 06 - 012 HTH (no HTH 10.10)

Clamp for the maintenance, replacement and movement of large excavator cylinders up to 4,500 kg and max  $\varnothing$  450 mm. Clamp side shift +/- 300 mm, 360° clockwise/anticlockwise clamp rotation, and +/- 27° cylinder rotation. This attachment is provided as standard with its support. Therefore, it is not necessary to purchase the Multi Tool Manipulator (ATT - 08 - 004).



**Suitable for  
RTH - HTH - TH**

CC 4.5

4,500 kg	4,420 - 2,290 mm	4,240 mm (max) 2,740 mm (min)	450 mm	+/- 300 mm	360°	+/- 27°	✓





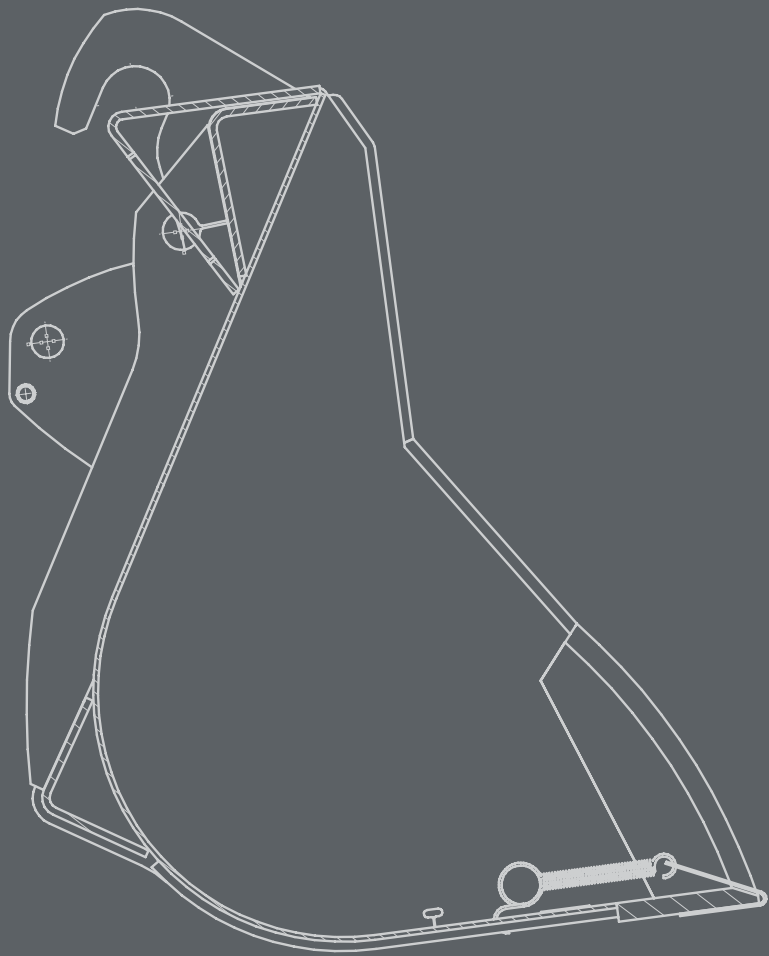



---

# BUCKETS

The buckets complete the range of accessories in the Magni world, simplifying the processes in the construction and maintenance sector. They are also excellent allies for the recycling, agriculture and paper supply chain thanks to the various capacities and undisputed performances that they can offer to the professional users.

**Warning:**

Compatibility depends also on the max capacity of the unit. please check max allowed weight. if in doubt, ask.



## BUCKET 1,000L

ATT - 07 - 001 Q-FIT I

Heavy-duty bucket with blade, capacity 1,000 kg. Suitable for moving aggregates, sand, gravel and similar materials around site.



**Suitable for**  
RTH - HTH 10.10 - TH

### CB 1000

			
1,000 l	800 l	2,450 mm	✓



## BUCKET 2,000 L

ATT - 07 - 003 Q-FIT I

Heavy-duty bucket with blade, capacity 2,000 kg. Designed to facilitate loading and unloading of materials. Suitable for moving aggregates, sand, gravel and similar materials around site.



**Suitable for**  
HTH (no HTH 10.10)

### CB 2000

			
2,090 l	1,660 l	2,460 mm	✓



## BUCKET 3,000L

ATT - 07 - 004 Q-FIT I

Heavy-duty bucket with blade, capacity 3,000 kg. Designed to facilitate loading and unloading of materials. Suitable for moving aggregates, sand, gravel and similar materials around site.



**Suitable for  
HTH**

### CB 3000

			
3,090 l	2,450 l	3,010 mm	✓



## WASTE BUCKET 2,000 L

ATT - 07 - 007 Q-FIT I

Aggregates bucket with capacity up to 2,000 kg.



**Suitable for  
RTH - HTH 10.10 - TH**

### BIM 2000

			
2,050 l	1,500 l	2,410 mm	✓



## BUCKET 4X1 5,900 L

ATT - 07 - 006 Q-FIT I

Versatile four-in-one bucket for various site uses. Ideal for picking up material with density below  $\leq 2.1 \text{ kg/m}^3$ . Sides with teeth to ensure a safe grip on cylindrical objects. Rear blade for terrain levelling and recovery.

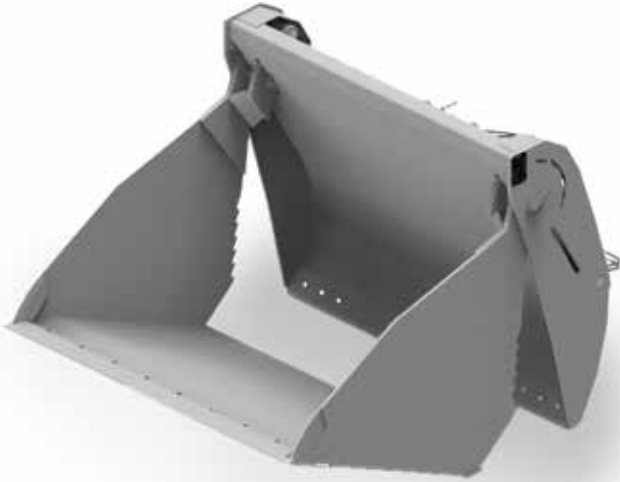

**Suitable for**  
**HTH**

### 4X1 5900

			
5,900 l	4,715 l	2,500 mm	✓



## BUCKET 4X1 850 L

ATT - 07 - 009 Q-FIT I

Bucket used for leveling and dumping by keeping the clamp closed and angling the shovel forward it will dig into the ground and the bucket will start to fill with material. Once the bucket is full we can load it directly into the dumper. The grading function enable the operator to lay out material to a required depth.

The depth can be varied by varying travelling speed or how gap the bucket is opened. Use the bucket to pick up materials or objects. Open the bucket and drive it over the object to clamp. Lower the bucket and safe close the bucket. Use the bucket as a bulldozer, you open up the clamp frame fully and by using the shovel frame allows the machine to push material forward a layer at a time.



**Suitable for**  
**RTH - HTH 10.10 - TH**

### 4X1 850L

			
850 l	550 l	2,300 mm	✓



## BUCKET 1,500 L

ATT - 07 - 010 Q-FIT I

Heavy-duty bucket with blade, capacity 1,500 L. Designed to facilitate loading and unloading of materials. Suitable for moving aggregates, sand, gravel and similar materials around site.



**Suitable for  
TH**

### CB 1500

			
1,500 l	1,200 l	2,450 mm	✓



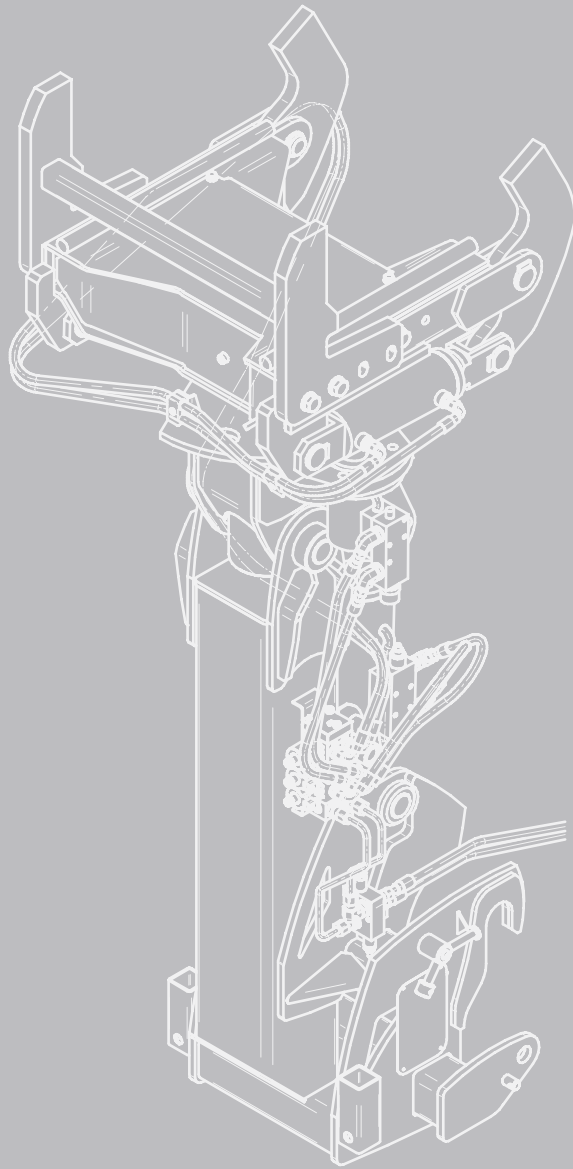

---

# SPECIALS

Category entirely dedicated to accessories with very specific uses. These are codes used to carry out special works, such as removing large trees, cleaning the road with snow shovels, installing glass at high altitude and servicing aircraft. In Magni we are known for the tailoring skills to sew ad hoc solutions to each specific market request, even for the most demanding customers.

**Warning:**

Compatibility depends also on the max capacity of the unit. please check max allowed weight. if in doubt, ask.



## TREE CUTTER

*ATT - 08 - 001 q-FIT I*

This grapple saw is the ideal solution for cutting down special trees. Spring suspension system for saw. Inclination function during the cutting process which prevents the saw from being damaged. Cutting diameter up to 75 cm.





**⚠ OPT-05-001** PRE ARRANGEMENT FOR TREE CUTTING DEVICE

**⚠ OPT-05-005** BOOM PROTECTION FOR TREE CUTTING DEVICE AND DUSTY ENVIRONMENTS IS MANDATORY

**Suitable for RTH**

### TREE CUTTER

		
1,280 mm	360°	✓







## SUSPENSION CYLINDERS TOOL

ATT - 08 - 002 Q-FIT I

Accessory specially designed for the safe removal of the suspension and front gearbox of dumpers.



**ATT-08-004** MULTITOOL - HANDLER FOR MULTIPLE ATTACHMENTS IS MANDATORY

**Suitable for**  
**HTH** (no HTH 10.10)

### SCT

Hub + suspension: 9,000 kg Only suspension: 7,000 kg	2,962 mm	60°	360°	360°	+/- 300 mm	Without adapter: 370 - 530 mm With adapter: 250 - 400 mm	✓



## WHEEL HUB TOOL

ATT - 08 - 003 Q-FIT I

Accessory specially designed for the safe removal of the rear gearmotor of dumpers.



**ATT-08-004** MULTITOOL - HANDLER FOR MULTIPLE ATTACHMENTS IS MANDATORY

**Suitable for**  
**HTH** (no HTH 10.10)

### RWHT

22,000 kg	842 - 1,322 mm	+/- 30°	✓



## MULTITOOL - HANDLER FOR MULTIPLE ATTACHMENTS



*ATT - 08 - 004 Q-FIT I*

Support designed for the use of the following attachments: CC, SCT and RWHT.

**Suitable for**  
**HTH** (no HTH 10.10)



## VACUUM MASTER

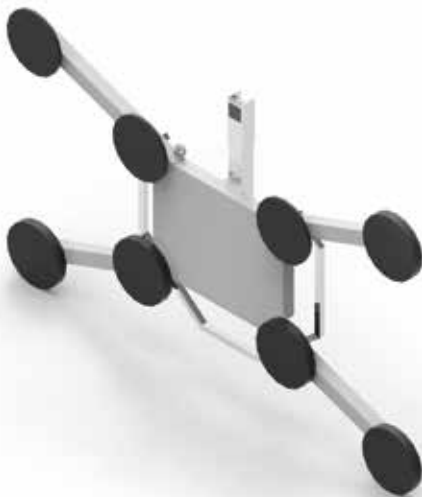

*ATT - 08 - 007*

Vacuum Master is the ideal accessory for safely moving pieces of glass in outdoor environments. It allows loads of up to 600 kg to be lifted in the horizontal and vertical position. The pieces can be rotated by 90° in one plane and 360° in another, and held at 45° increments. This allows for perfect alignment of the glass components and their insertion in the façade. Thanks to its modular structure, the lifting device can be perfectly adapted to the dimensions of the part. An LED indicator provides information on the charge status of the 12 V battery, which is rechargeable and replaceable. The regulated vacuum pump ensures constant operational availability for up to 8 hours.

**Suitable for**  
**RTH**

### VACUUM MASTER

CAPACITY	N° SUCTION CUPS	Ø SUCTION CUPS	LIFTING CAPACITY	BATTERY	BATTERY POWER	WORKING TEMPERATURE	
600 kg	8	300 mm	75 kg/aspiration plate	12 V / 4 A	7 Ah	0°C a 40°C	



## CONCRETE MIXER 700 L

ATT - 08 - 014 Q-FIT I

The concrete bucket is equipped with bottom and helix made of wear resistant steel HB400, fixed safety rounded grill with bag breaker, electric valve, hydraulic hoses, electric connection kit., hydraulic opening of the bottom through a cylinder with covered rod and unloading pipe.



**⚠️ OPT-02-022** DOUBLE HYDRAULIC OUTPUT AT THE BOOM HEAD IS MANDATORY

**Suitable for**  
**RTH - HTH 10.10 - TH**

### MB 700 SL

CLASS	WIDTH	CAPACITY	TRANSMISSION	WEIGHT UNLADEN	
3	2,090 mm	700 lt	chain	765 kg	



## RECYCLING PAPER CLAMP

ATT - 08 - 018 Q-FIT I

Clamp designed for the recycling industry, heavy logistics and the paper / cellulose supply chain. Designed to ensure maximum visibility of the frame from all angles. The excellent profile of the arms allows good functionality without compromising resistance. The section of the frame is made of steel, the arm bar in extruded steel alloy and the bases of the cast iron arms therefore a guarantee of durability and reliability. The built-in hydraulic flow distributors and the bidirectional pressure regulating valve regulate a fast and synchronized movement of the arms.



**Suitable for**  
**RTH - HTH 10.10 - TH**

### PAPER CLAMP

CAPACITY AT BARYCENTER	FRAME WIDTH	FRAME HEIGHT	OPENING INTERNAL - INTERNAL	CLAMP	CLAMP THICKNESS	MINIMUM TROLLEY PLATE	HYDRAULIC FUNCTION
3,200 kg @500 mm	1,250 mm	751 mm	700 - 2,300 mm	550 x 750 mm	Fixed 78 mm	811 mm	2







## TOOL FOR CONVEYOR BELT MAINTENANCE UP TO 25T

*ATT - 08 - 008 Q-FIT I*

Attachment that facilitates the replacement of conveyor belt belts. The attachment has two stabilization feet to be used during the unwinding / winding phase and a hydraulically removable column to allow you to grab or release the drum centered on the motorized washers. It is possible to move a drum on which the belt is wound up to 4m in diameter and 2.25m in length, with a capacity of up to 25t.

**Suitable for**  
**HTH 35.12 - HTH 50.14**

**CBR**

				
25,000 kg	1,192,5 - 2,842,5 mm	4,449 - 6,914 mm	360°	✓



## HANDLING AND DEMOLITION GRAPPLE

*ATT - 08 - 011 Q-FIT I*

Material loading bucket with reinforced structure to ensure safe, solid loading. Rotation: 360°; opening: 1,685 mm.

 **OPT-02-022** DOUBLE HYDRAULIC OUTPUT AT THE BOOM HEAD IS MANDATORY

**Suitable for**  
**RTH - HTH 10.10 - TH**

**BM 120**

			
2,000 kg	1,685 mm	360°	✓

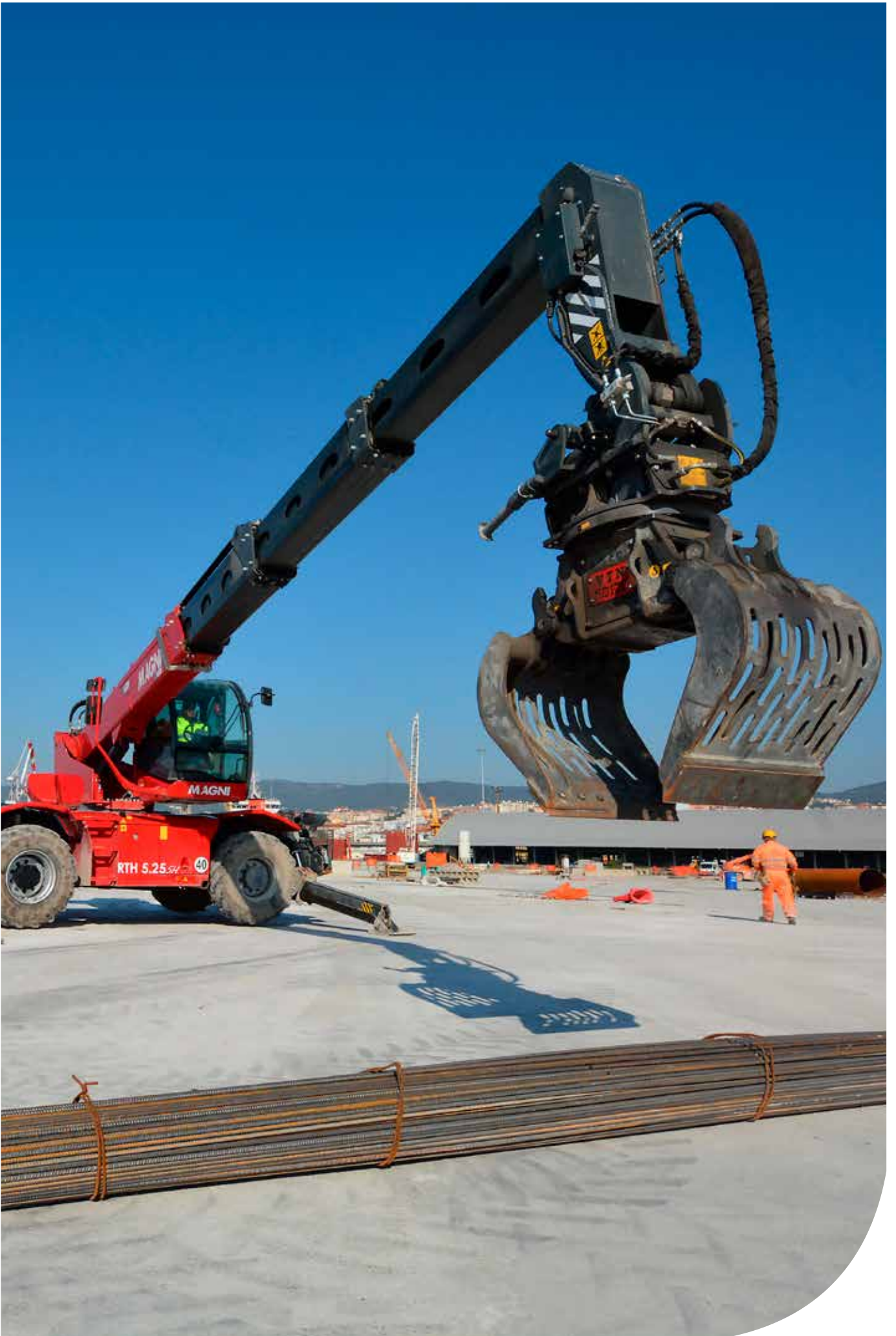

## SNOW BLADE

ATT - 08 - 009 Q-FIT I

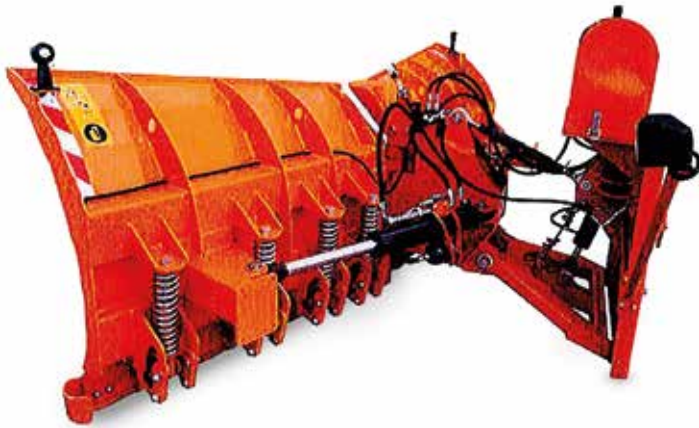

Snow plough attachment featuring steel load-bearing structure and quick-coupling counterplate to DIN 76060/A, or alternatively a three-point coupling structure for front three-point hitches as typically found on agricultural machinery. Front wing made from two 100% steel sections. Scraper blade with six independent sections in wear-resistant steel. Impact mitigation system featuring steel springs with adjustable force on each individual sector of the scraper blade. These flex backwards (against the direction of travel) in the event of a collision. Powder-coated steel load-bearing structure, with special rustproofing treatment and RAL 2011 (orange) final enamelling. Black HDPE wing. Overpressure valve to damp lateral impacts, R2 piping with unified quick fittings and couplings. The transformable LTL blade can be set in a wedge position, inclined blade facing to the left or right, or inverse wedge (spoon shaped).

**Suitable for**  
**HTH 16.10 - HTH 27.11**

### SNOW BLADE

ATTACHMENT WEIGHT	HEIGHT IN THE CENTER	HEIGHT EXTERNAL SIDE	WORKING WIDTH	MAX. WIDTH WHILE MOVING	
900 kg	980 mm	1,150 mm	3.47 mt	4,00 mt	



## COILS HANDLER 22T (CLAMP)







ATT - 08 - 013 Q-FIT I



Attachment designed specifically for moving large steel coils in heavy industry, with diameters from 1,200 mm up to 1,600 mm. Pin inclination +/- 90° and pin side shift +/- 300 mm.

**Suitable for**  
**HTH** (no HTH 10.10)

### CH22T

					
22,000 kg	1,600 mm	1,200 mm	+/- 90°	+/- 300 mm	



## CONCRETE BUCKET 600 L

ATT - 08 - 010 Q-FIT I

Concrete bucket, capacity 600 l, with opening via hydraulic piston.

**Suitable for**  
RTH - HTH 10.10 - TH

### BB600

					
600 l	1,420 mm	2,020 mm	1,180 mm	1,130 mm	X



## COILS HANDLER 30T (SPUR)

ATT - 08 - 012 Q-FIT I

Attachment designed specifically for moving large steel coils in heavy industry. Equipped with leveling indicator and an extra translation +/- 300 mm to facilitate logistics operations.

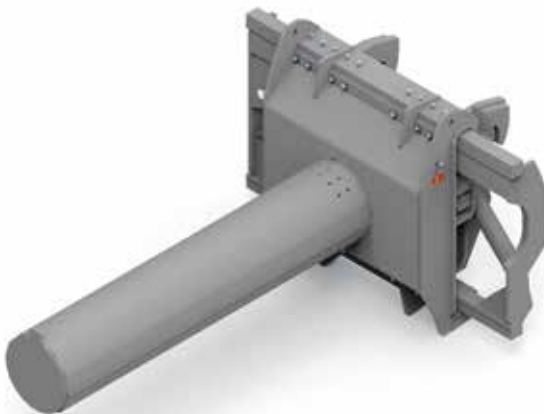

**Suitable for**  
HTH (no HTH 10.10)

### SCT30T

			
30,000 kg	2,015 mm	+/- 300 mm	✓

# ALPHABET INDEX

CODE	PRODUCT	DESCRIPTION	PAGE
Q-FIT I			
<b>PLATFORMS</b>			
<b>ATT - 01 - 007</b>	REP 2 - 4,5	Extendable rotating platform	1-3
<b>ATT - 01 - 009</b>	REP 2 - 5.5	Extendable rotating platform	1-4
<b>ATT - 01 - 011</b>	REP 2 - 6.5	Extendable rotating platform	1-4
<b>ATT - 01 - 016</b>	REP 10.2 - 4,7	Extendable rotating platform	1-8
<b>ATT - 01 - 026</b>	REP 5.2 - 4,5 W0,6	Extendable rotating platform + winch 600 kg	1-8
<b>ATT - 01 - 018</b>	RPRAB 10 - 3,5	Extendable rotating platform asbestos 1000kg + frontal opening	1-9
<b>ATT - 01 - 020</b>	RRP 10.2,5 - 3,5	Extendable rotating platform for roofs	1-9
<b>ATT - 01 - 022</b>	TP 2.10	Fixed telescopic platform	1-10
<b>ATT - 01 - 027</b>	CP 1,8	Mining platform	1-5
<b>ATT - 01 - 001</b>	P1,4	Platform	1-2
<b>ATT - 01 - 003</b>	RP1,4	Rotating platform	1-2
<b>ATT - 01 - 005</b>	RP2,2	Rotating platform	1-3
<b>ATT - 01 - 013</b>	CRP 5	Rotating platform for tunnels	1-5
<b>ATT - 01 - 024</b>	TP O-U	Telescopic Platform that can work either positive or negative TP O/U	1-10
<b>WINCHES</b>			
<b>ATT - 02 - 001</b>	W2,7	Winch 2,700 kg	2-2
<b>ATT - 02 - 010</b>	W3 - 6	Winch 3,000 kg / 6,000 kg	2-3
<b>ATT - 02 - 002</b>	W3,5	Winch 3,500 kg	2-2
<b>ATT - 02 - 009</b>	W3,5 - 1,75	Winch 3,500 kg / 1,750 kg	2-3
<b>ATT - 02 - 019</b>	W5	Winch 5.000 kg	2-3
<b>ATT - 02 - 004</b>	W6	Winch 6.000 kg	2-3
<b>ATT - 02 - 006</b>	W8	Winch 8.000 kg	2-4
<b>ATT - 02 - 018</b>	W13	Winch 13,000 kg	2-6
<b>ATT - 02 - 008</b>	W16	Winch 16,000 kg	2-4
<b>ATT - 02 - 014</b>	AWB6	Winch fitted at the base of the boom 6 t articulated for road circulation	2-7
<b>ATT - 02 - 013</b>	WB6	Winch fitted at the base of the boom 6 t	2-6
<b>ATT - 02 - 016</b>	WB6	Winch fitted at the base of the boom 6 t	2-7



<b>CODE</b>	<b>PRODUCT</b>	<b>DESCRIPTION</b>	<b>PAGE</b>
<b>Q-FIT I</b>			
<b>FORK CARRIAGES</b>			
<b>ATT - 03 - 032</b>	FCEP30T 2,4 R	Extendable 30 t fork carriage with positioner	3-17
<b>ATT - 03 - 003</b>	FCF5T 1,3	FEM fork carriage 5 t	2-1
<b>ATT - 03 - 010</b>	FCF6T 1,3	FEM fork carriage 6 t	3-5
<b>ATT - 03 - 018</b>	F10T	Fork carriage 10 t	3-8
<b>ATT - 03 - 019</b>	FCP10T	Fork carriage 10 t (with fork positioner)	3-8
<b>ATT - 03 - 020</b>	FC10T 2,5 C	Fork carriage 10 t (with fork positioner)	3-11
<b>ATT - 03 - 021</b>	FCP13T	Fork carriage 13 t (with fork positioner)	3-11
<b>ATT - 03 - 022</b>	F16T	Fork carriage 16 t	3-12
<b>ATT - 03 - 024</b>	FCPT16 2,4	Fork carriage 16 t (with fork positioner and sideshift)	3-13
<b>ATT - 03 - 023</b>	FCP16T	Fork carriage 16 t (with fork positioner)	3-12
<b>ATT - 03 - 025</b>	FCP16T C	Fork carriage 16 t (with fork positioner)	3-13
<b>ATT - 03 - 026</b>	FCP20T	Fork carriage 20 t (with fork positioner)	3-14
<b>ATT - 03 - 027</b>	FCP24T	Fork carriage 24 t (with fork positioner)	3-14
<b>ATT - 03 - 028</b>	FCP24T 2,4	Fork carriage 24 t (with fork positioner)	3-15
<b>ATT - 03 - 029</b>	FCP27T	Fork carriage 27 t (with fork positioner)	3-15
<b>ATT - 03 - 031</b>	FCPT30T 2,4 R	Fork carriage 30 t (with fork positioner and sideshift)	3-16
<b>ATT - 03 - 030</b>	FCP30T	Fork carriage 30 t (with fork positioner)	3-16
<b>ATT - 03 - 033</b>	FCP35T	Fork carriage 35 t (with fork positioner)	3-17
<b>ATT - 03 - 037</b>	FCP50T	Fork carriage 50 t (with fork positioner)	3-18
<b>ATT - 03 - 009</b>	FC6T 6x5 FT	Fork carriage 6 t	3-5
<b>ATT - 03 - 005</b>	PCF	Grid for load protection for FEM fork carriage	2-2
<b>ATT - 03 - 038</b>	PC	Grid for load protection for standard fork carriage	2-2
<b>ATT - 03 - 001</b>	FC5T	Standard fork carriage 5 t	2-1
<b>ATT - 03 - 039</b>	FC5T FIX	Standard fork carriage 5 t (TH)	2-3
<b>ATT - 03 - 040</b>	FC5,5T FIX	Standard fork carriage 5,5 t (TH)	2-3
<b>ATT - 03 - 006</b>	FC6T	Standard fork carriage 6 t	3-4
<b>ATT - 03 - 008</b>	FC6T	Standard fork carriage 6 t	3-4
<b>ATT - 03 - 012</b>	FC6T FIX	Standard fork carriage 6 t	3-6
<b>ATT - 03 - 015</b>	FC8T	Standard fork carriage 8 t	3-7
<b>ATT - 03 - 014</b>	FC6T 72x72 FIX	Wide fork carriage 6 t	3-6
<b>ATT - 03 - 017</b>	FC8T 72x72	Wide fork carriage 8 t	3-7

# ALPHABET INDEX

CODE	PRODUCT	DESCRIPTION	PAGE
Q-FIT I			
<b>JIB WITH WINCH</b>			
<b>ATT - 04 - 023</b>	JCC3000	3,000kg "swan neck" jib	4-9
<b>ATT - 04 - 021</b>	JT2500	BTelescopic jib 2,500/1,500 kg	4-8
<b>ATT - 04 - 009</b>	JW1200/3000	Jib 1,200/3,000 kg with winch	4-4
<b>ATT - 04 - 011</b>	JW 1500	Jib 1,500 kg with winch	4-4
<b>ATT - 04 - 017</b>	JW2700	Jib 2,700 kg with winch	4-7
<b>ATT - 04 - 013</b>	J2000	Jib 2.000 kg	4-6
<b>ATT - 04 - 015</b>	JW 2000	Jib 2.000 kg with winch	4-6
<b>ATT - 04 - 019</b>	JW 3000	Jib 3,000 kg with winch	4-8
<b>ATT - 04 - 001</b>	J600	Jib 600 kg	4-2
<b>ATT - 04 - 003</b>	JV 800	Jib 800 kg for winch at the base of the boom	4-2
<b>ATT - 04 - 005</b>	JW800	Jib 800 kg with winch	4-3
<b>ATT - 04 - 007</b>	JW800/1500	Jib 800/1,500 kg with winch	4-3
<b>HOOKS</b>			
<b>ATT - 05 - 014</b>	H6	Hook 5 t	5-2
<b>ATT - 05 - 001</b>	H6	Hook 6 t	5-2
<b>ATT - 05 - 003</b>	H8	Hook 8 t	5-3
<b>ATT - 05 - 005</b>	H10	Hook 10 t	5-3
<b>ATT - 05 - 013</b>	H13	Hook 13 t	5-4
<b>ATT - 05 - 007</b>	H16S	Hook 16 t	5-4
<b>ATT - 05 - 008</b>	H20S	Hook 20 t	5-5
<b>ATT - 05 - 009</b>	H30S	Hook 30 t	5-6
<b>ATT - 05 - 011</b>	H40S	Short hook 40 t	5-6
<b>ATT - 05 - 012</b>	H50	Hook 50 t	5-7

<b>CODE</b>	<b>PRODUCT</b>	<b>DESCRIPTION</b>	<b>PAGE</b>
<b>Q-FIT I</b>			
<b>CLAMPS</b>			
<b>ATT - 06 - 010</b>	CC	Cylinder handler 11 t	6-7
<b>ATT - 06 - 011</b>	CC4,5	Cylinder handler 4.5 t	6-7
<b>ATT - 06 - 012</b>	CC4,5	Cylinder handler 4.5 t	6-7
<b>ATT - 06 - 008</b>	PD CR5	Demolition grab	6-6
<b>ATT - 06 - 009</b>	PC 1000	Pipes handler 1,000 kg	6-6
<b>ATT - 06 - 001</b>	RC 4T	Rib Handler 4 t	6-2
<b>ATT - 06 - 007</b>	TC16.63 CP	Tyre handler 16 t	6-5
<b>ATT - 06 - 003</b>	TC2,5.25	Tyre handler 2.5 t	6-2
<b>ATT - 06 - 004</b>	TC3,5	Tyre handler 3.5 t	6-4
<b>ATT - 06 - 005</b>	TC3,8.49	Tyre handler 3.8 t	6-4
<b>ATT - 06 - 006</b>	TC08.63	Tyre handler 8 t	6-5
<b>BUCKETS</b>			
<b>ATT - 07 - 001</b>	CB 1000	Bucket 1,000 l	7-2
<b>ATT - 07 - 010</b>	CB 1500	Bucket 1,500 l	7-5
<b>ATT - 07 - 003</b>	CB 2000	Bucket 2,000 l	7-2
<b>ATT - 07 - 004</b>	CB 3000	Bucket 3,000 l	7-3
<b>ATT - 07 - 006</b>	4X1 5900	Bucket 4X1 5,900 l	7-4
<b>ATT - 07 - 009</b>	4X1 850L	Bucket 4X1 850 l	7-4
<b>ATT - 07 - 007</b>	BIM 2000	Waste bucket 2,000 l	7-3

# ALPHABET INDEX

<b>CODE</b>	<b>PRODUCT</b>	<b>DESCRIPTION</b>	<b>PAGE</b>
<b>Q-FIT I</b>			
<b>SPECIALI</b>			
<b>ATT - 08 - 013</b>	CH22T	Coils handler 22T (grab)	8-8
<b>ATT - 08 - 012</b>	SCT30T	Coils handler 30T (spur)	8-9
<b>ATT - 08 - 010</b>	BB600	Concrete bucket 600 l	8-9
<b>ATT - 08 - 014</b>	MB 700 SL	Concrete mixer700 l	8-5
<b>ATT - 08 - 011</b>	BM 120	Handling and demolition grapple	8-6
<b>ATT - 08 - 004</b>	MTM	Multitool - handler for multiple attachments	8-4
<b>ATT - 08 - 018</b>	-	Recycling paper clamp	8-5
<b>ATT - 08 - 009</b>	-	Snow blade	8-9
<b>ATT - 08 - 002</b>	SCT	Suspension cylinders tool	8-3
<b>ATT - 08 - 008</b>	CBR	Tool for conveyor belt maintenance up to 25T	8-6
<b>ATT - 08 - 001</b>	-	Tree cutter	8-2
<b>ATT - 08 - 007</b>	-	Vacuum master	8-4
<b>ATT - 08 - 003</b>	RWHT	Wheel hub tool	8-3





# LEGEND



## CONSTRUCTION & BUILDING

Magni telescopic handlers, designed for the construction sector, allow you to position and maneuver any type of load in height or with reach with maximum safety. The intuitive controls of the touch screen display and the ergonomic and panoramic cabin with all the comforts for prolonged use by the operator, guarantee immediate operation.

- FRAMING
- DEMOLITION
- COVERING
- RESTORATION & RENOVATION



## HEAVY INDUSTRIAL

Magni handling solutions are known for their reliability and performance. Even in a demanding sector such as the heavy industry, they live up to expectations for the duration of the projects: construction of sites and conduits for the passage of gas, support for activities and maintenance of machinery on site.

- OIL&GAS
- HARBOURS
- DEFENSE
- AIRPORT
- AGROINDUSTRIAL
- TUNNELS
- RAILWAYS



## MINING

The HTH Magni range consisting of seven models is the perfect solution for working with exceptional performance in open-pit or underground mines. From 10 to 45 tons they are the most reliable and safest partners for working in the most demanding and extreme situations. Versatile and off-road, the machines of the HTH series save time and work in complete safety for better productivity.

- MAINTENANCE OF CYLINDERS AND JACKS
- CHANGE DUMPER TRUCK TYRES
- CONVEYOR BELTS HANDLER
- HEAVY LOGISTICS



## FORESTRY

The special tree cutting attachment is the best solution for handling, moving and cutting wooden trunk, so you can handle rough logs, boards or poles in complete safety and with great precision, on stable or rough terrain.



## TUNNELS

Attachments for maintenance and construction tunnels.



## BRIDGE INSPECTION

Accessories dedicated to the ordinary inspection and maintenance of bridges and viaducts.



## RECYCLING

Accessory dedicated to the recycling industry.



## FEATURED PROJECTS

Special applications.

 **COMPTOIR DU LEVAGE**

Vente, location de matériel avec ou sans opérateur et gestion de projet

**comptoirdulevage.fr**

**07 68 55 39 82    contact@comptoirdulevage.fr**

*SIRET : 850 301 227 00011*